



Care with Trust...
ENDO TECH
GROUP OF INDUSTRIES

30 YEARS
MANUFACTURERS



**MANUFACTURERS OF HIGH
QUALITY SUCTION TUBE INSTRUMENTS**

• SUCTION TUBES

Ø 2 mm int.
Ø 3 mm int.
Ø 4 mm int.

Ø 3 mm
Ø 4 mm

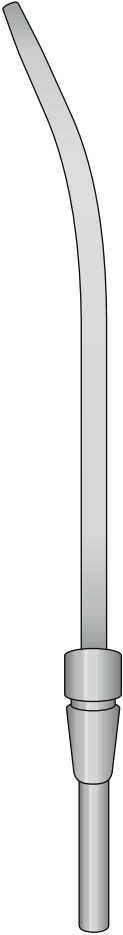

Mc KESSON
ET.2022-01
180 mm

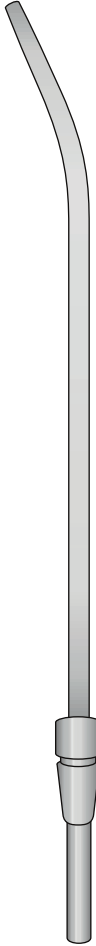

Mc KESSON
ET.2022-02
230 mm

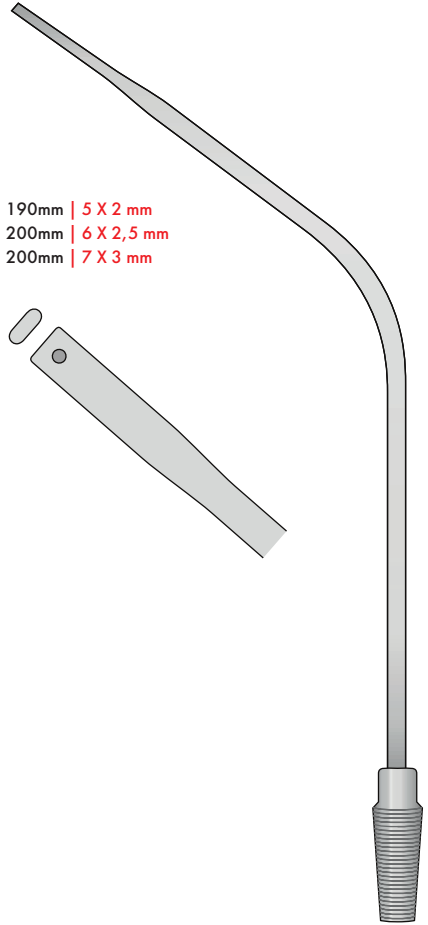

190mm | 5 X 2 mm
200mm | 6 X 2,5 mm
200mm | 7 X 3 mm

Mc KESSON
ET.2022-03
180 mm

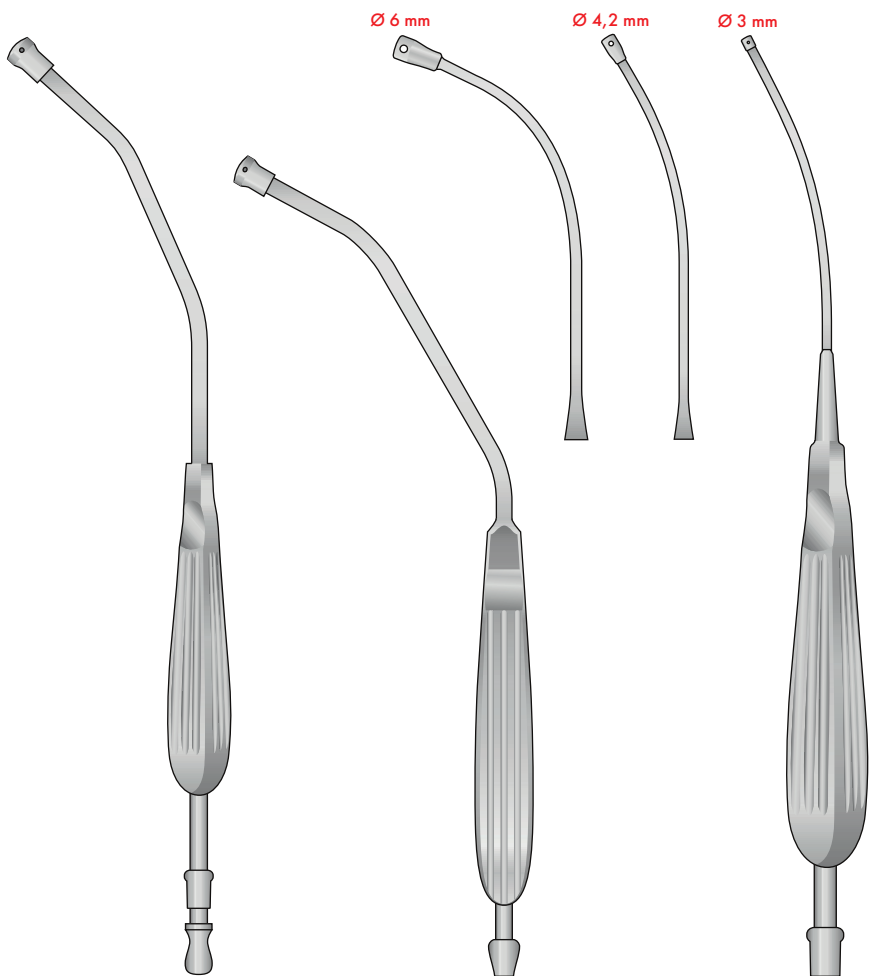

YANKAUER
ET.2022-04
310 mm

BABY-YANKAUER
ET.2022-05
200 mm

ANDREWS-PYNCHON
ET.2022-06
250 mm

• SUCTION TUBES

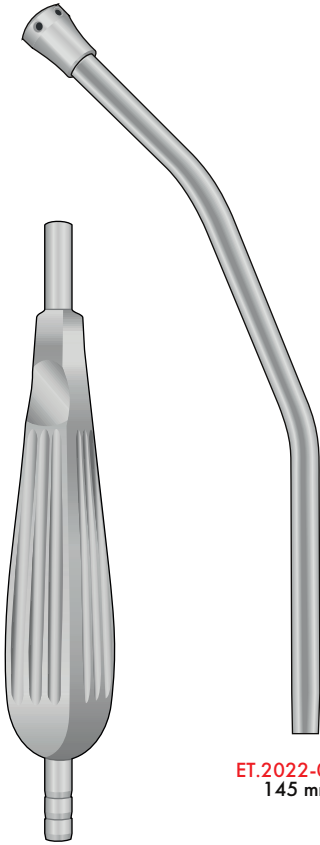

ET.2022-07-04
150 mm



ET.2022-07-1
145 mm

ET.2022-07-2
105 mm

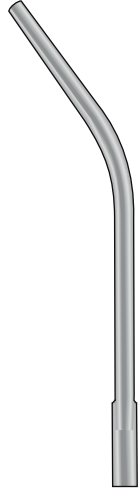

ET.2022-07-3
100 mm

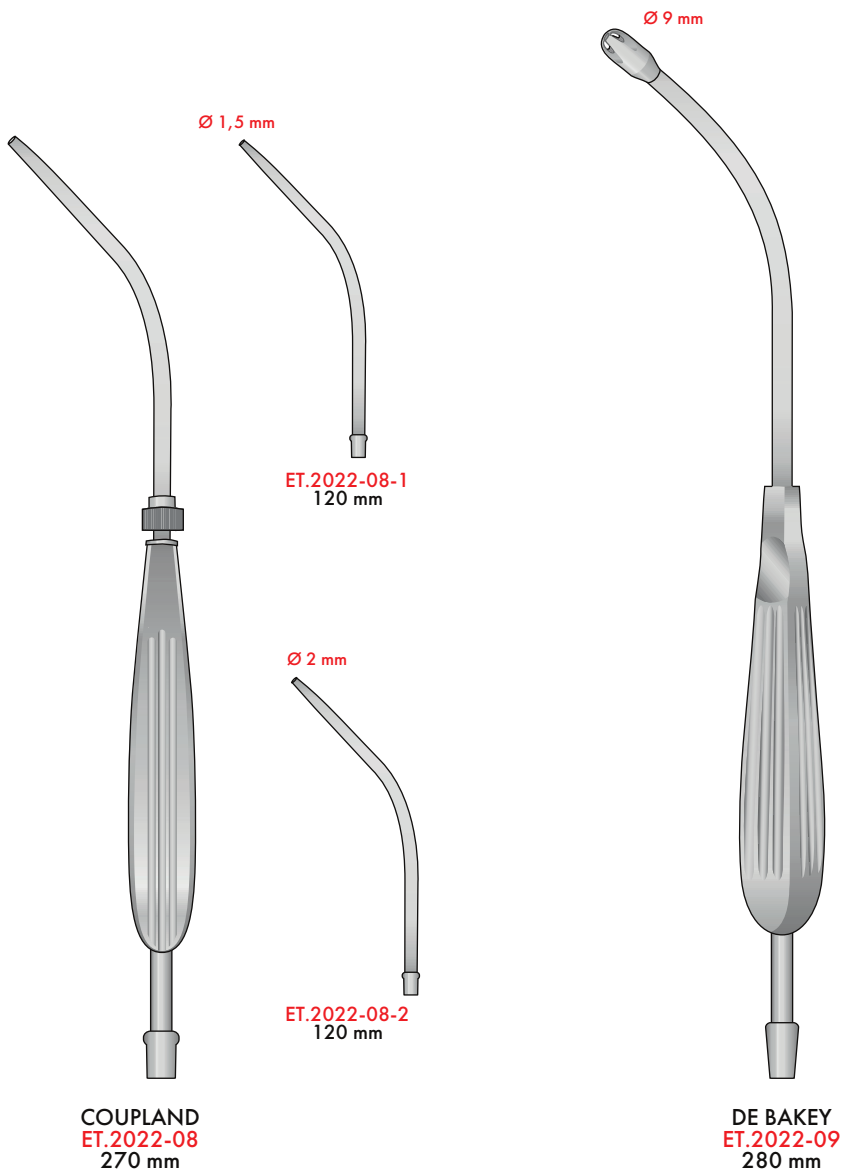

• SUCTION TUBES

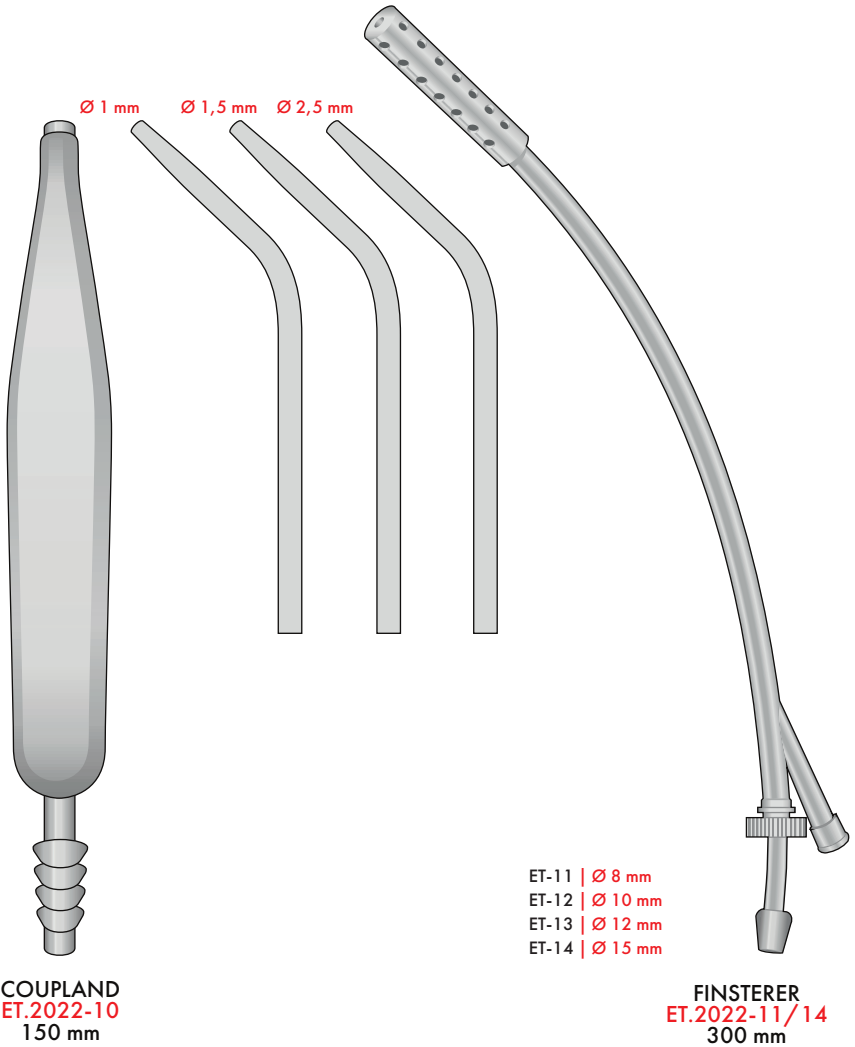

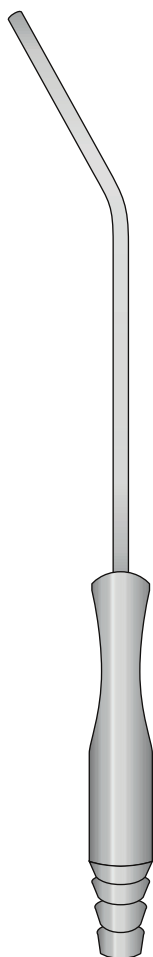

WULLSTEIN
ET.2022-15
 140 mm

Ø 0,5 mm



40 mm

Ø 0,7 mm



40 mm

Ø 0,9 mm



40 mm

Ø 1,2 mm

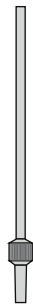

40 mm

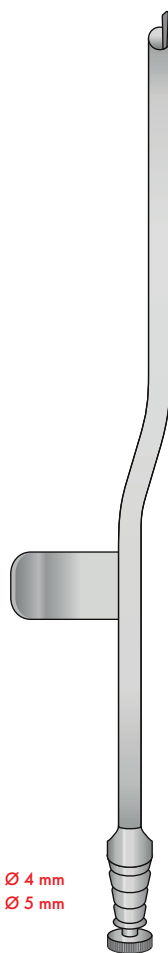

ET-17 | Ø 4 mm
 ET-18 | Ø 5 mm

SAUG-RASPATORIUM
ET.2022-16/18
 200 mm

• SUCTION TUBES

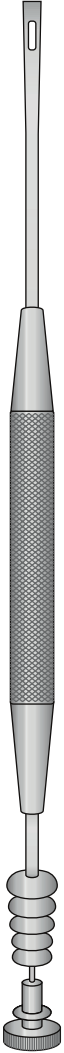

GORNEY
ET.2022-19
180 mm



GORNEY
ET.2022-20
200 mm

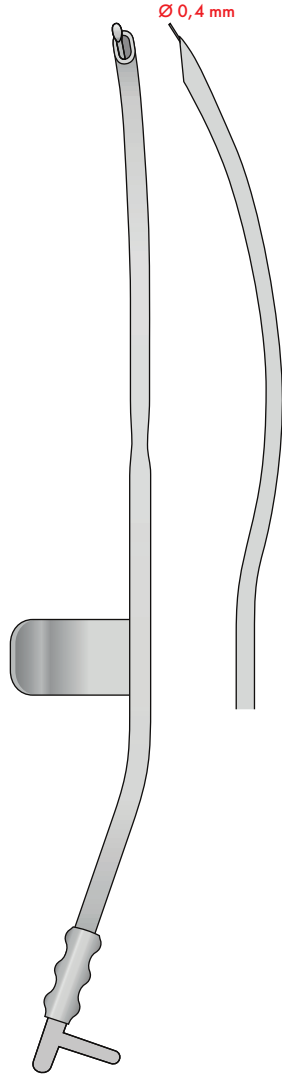

FINSTERER
ET.2022-11/14
300 mm



NUBOER
ET.2022-15
210 mm



NUBOER
ET.2022-16
210 mm

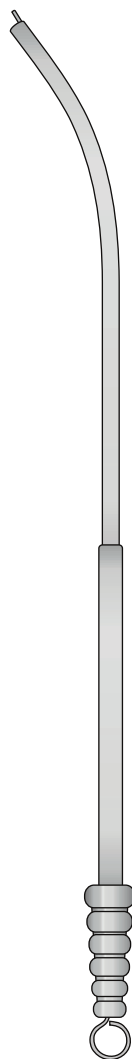

ET.2022-17
230 mm

• SUCTION TUBES

YASARGIL ET.2022-18/ET.30

YASARGIL	Usable length	Ø
ET-18	130 mm	1,5 mm
ET-19	150 mm	1,5 mm
ET-20	180 mm	1,5 mm
ET-21	220 mm	1,5 mm

YASARGIL	Usable length	Ø
ET-22	130 mm	2,0 mm
ET-23	150 mm	2,0 mm
ET-24	180 mm	2,0 mm
ET-25	220 mm	2,0 mm

YASARGIL	Usable length	Ø
ET-26	130 mm	2,5 mm
ET-27	150 mm	2,5 mm
ET-28	180 mm	2,5 mm
ET-29	220 mm	2,5 mm

YASARGIL	Usable length	Ø
ET-30	130 mm	3,5 mm
ET-31	150 mm	3,5 mm
ET-32	180 mm	3,5 mm
ET-33	220 mm	3,5 mm

YASARGIL	Usable length	Ø
ET-34	180 mm	4,5 mm

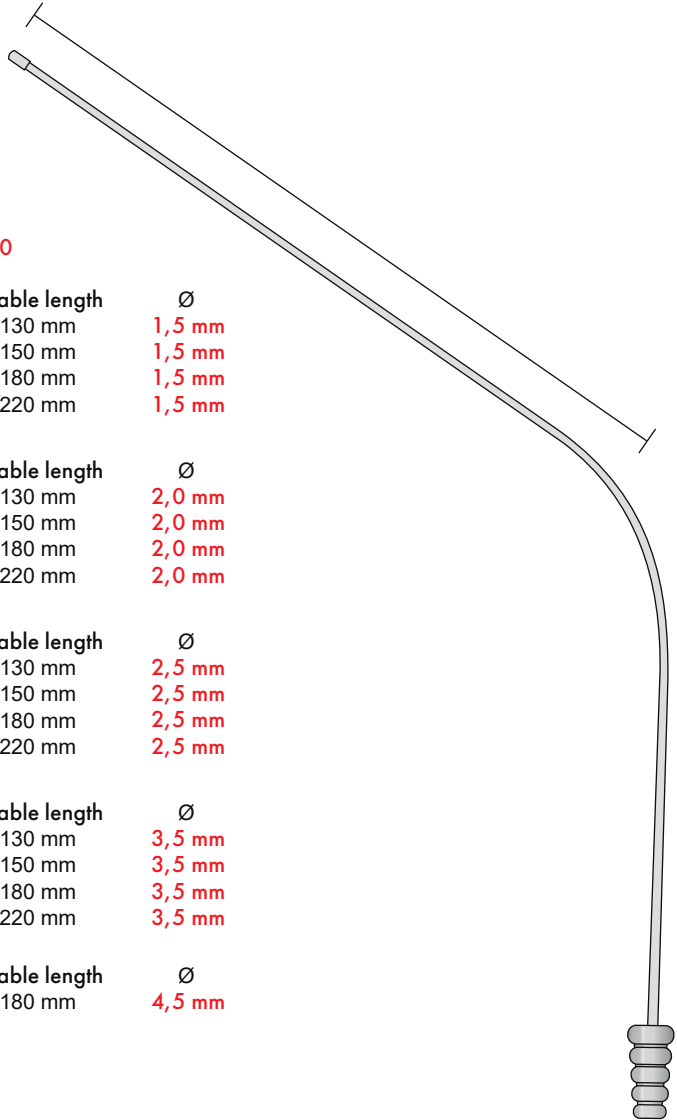

YASARGIL ET.2022-18/ET.34

ET-180 | Ch. 6
 ET-181 | Ch. 7
 ET-182 | Ch. 9
 ET-183 | Ch. 12
 ET-184 | Ch. 15

ET-200 | Ch. 6
 ET-200 | Ch. 7
 ET-200 | Ch. 9
 ET-200 | Ch. 12
 ET-200 | Ch. 15

ET-180 | Ch. 6
 ET-181 | Ch. 7
 ET-182 | Ch. 9
 ET-183 | Ch. 12
 ET-184 | Ch. 15

FERGUSSON
 ET.2022-35
 180 mm

FRAZIER
 ET.2022-36
 180 mm

PLESTER
 ET.2022-37
 200 mm

• SUCTION TUBES

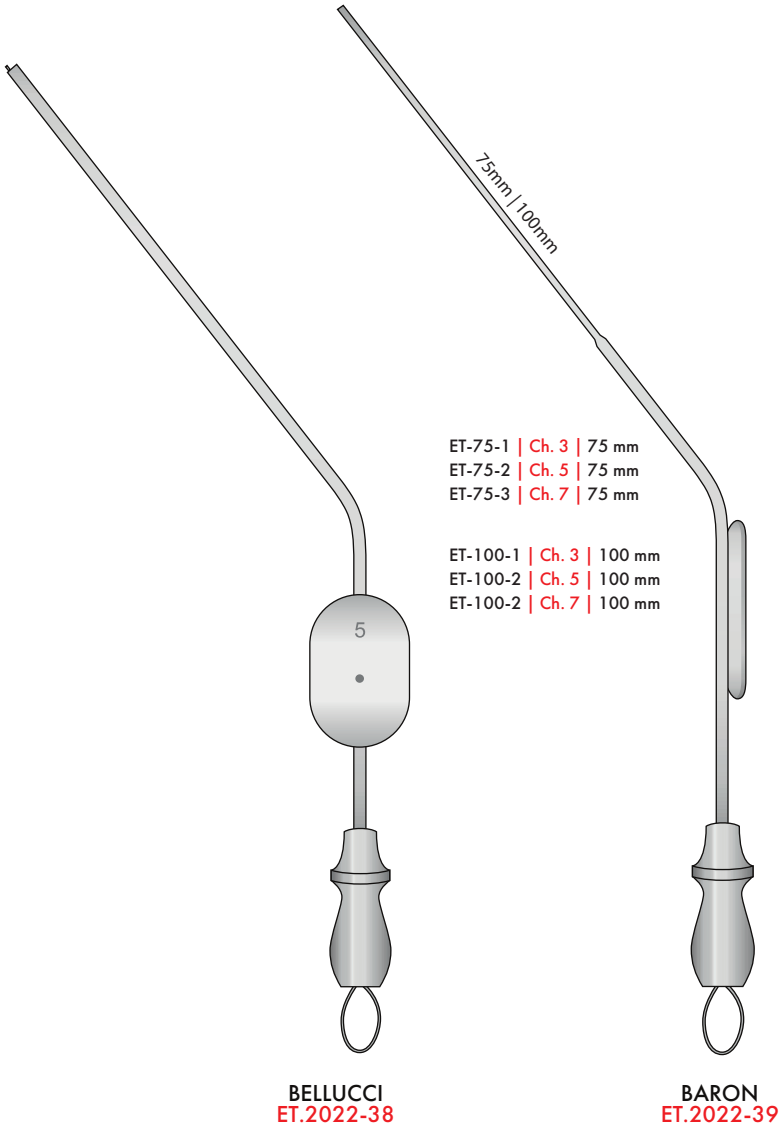



ROTAN
ET.2022-40
Charr. 5 | Charr. 10

ROTAN
ET.2022-41
Charr. 3 | Charr. 7

ROTAN
ET.2022-42
Charr. 7 | Charr. 12

• SUCTION TUBES

ET-44-1 | Ø 3 mm | 160 mm
 ET-44-2 | Ø 3 mm | 200 mm

ET-45-1 | Ø 3 mm | 160 mm
 ET-45-2 | Ø 3 mm | 200 mm

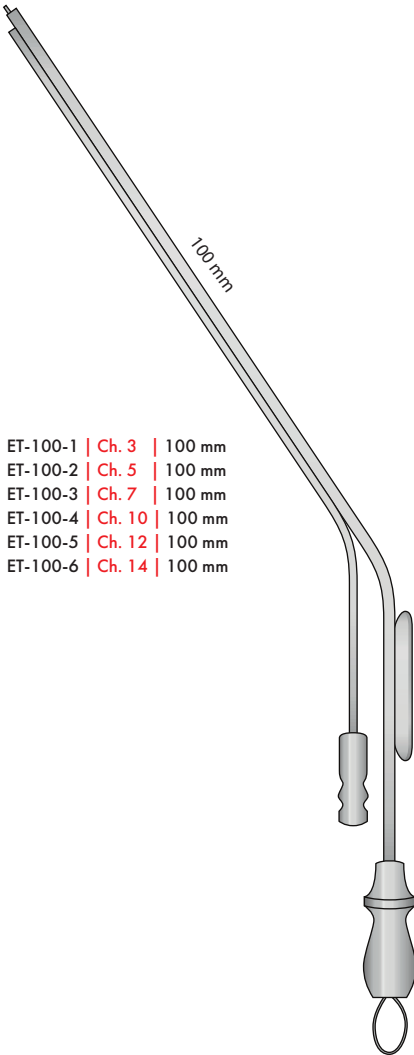

ET-100-1 | Ch. 3 | 100 mm
 ET-100-2 | Ch. 5 | 100 mm
 ET-100-3 | Ch. 7 | 100 mm
 ET-100-4 | Ch. 10 | 100 mm
 ET-100-5 | Ch. 12 | 100 mm
 ET-100-6 | Ch. 14 | 100 mm

HOUSE
 ET.2022-43

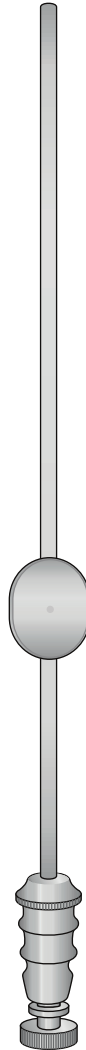

WERTHEIMER
 ET.2022-44
 160 mm

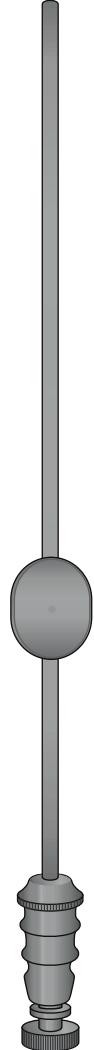

FRAZIER
 ET.2022-45
 160 mm

ET-46-1 | Ch. 12 | 210 mm
ET-46-2 | Ch. 15 | 210 mm

Ø 5,5 mm

Ø 5,5 mm

Ø 8 mm

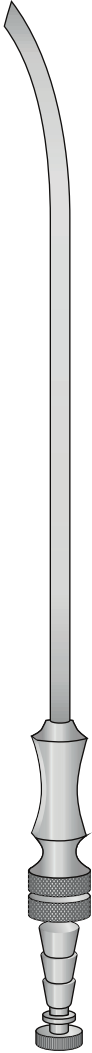

ADSON
ET.2022-46
210 mm

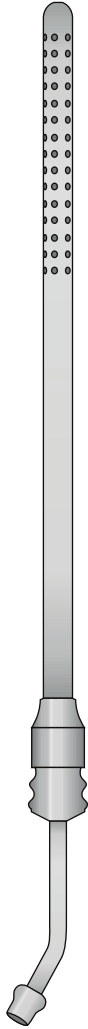

POOLE
ET.2022-47
190 mm

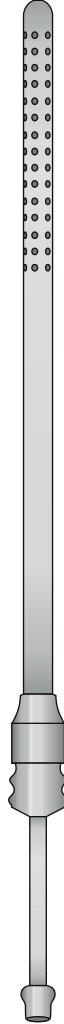

POOLE
ET.2022-48
190 mm

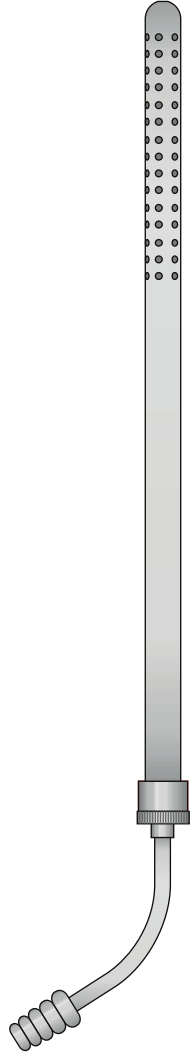

POOLE
ET.2022-49
220 mm

• SUCTION TUBES

Ø 10 mm

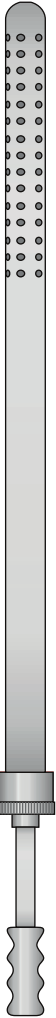

POOLE
ET.2022-50
240 mm

Ø 10 mm

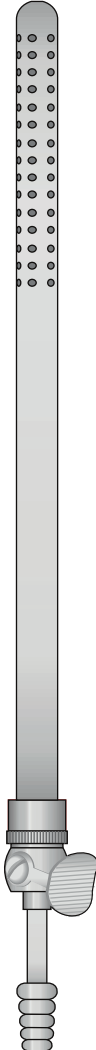

WALTON-POOLE
ET.2022-51
240 mm

Ø 10 mm

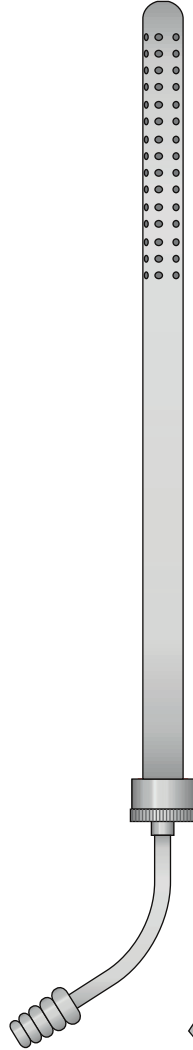

POOLE
ET.2022-52
240 mm

Ø 12 mm

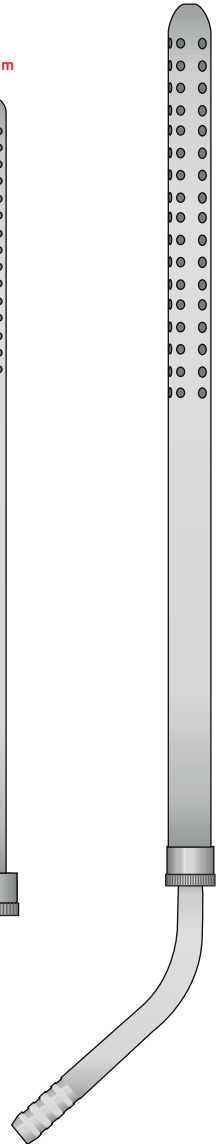

POOLE
ET.2022-53
320 mm

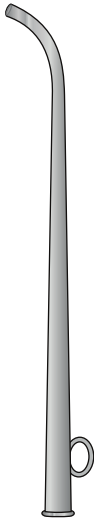

- ET-55 Ø 3,0 mm
- ET-56 Ø 3,5 mm
- ET-57 Ø 4,0 mm
- ET-58 Ø 4,5 mm
- ET-59 Ø 5,0 mm

ITARD
ET.2022-55 / ET59
 145 mm

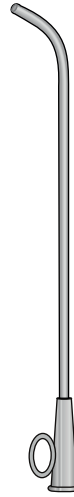

ET-67

- ET-60 Ø 2,0 mm
- ET-61 Ø 2,5 mm
- ET-62 Ø 3,0 mm
- ET-63 Ø 3,5 mm
- ET-64 Ø 4,0 mm
- ET-65 Ø 4,5 mm
- ET-66 Ø 5,0 mm

HARTMANN
ET.2022-60 / ET-65
 150 mm

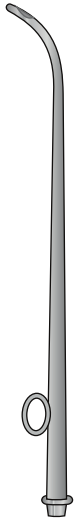

- ET-66 Ø 1,5 mm
- ET-67 Ø 1,7 mm
- ET-65 Ø 2,0 mm
- ET-69 Ø 2,5 mm
- ET-70 Ø 3,0 mm

SIEBENMANN
ET.2022-66 / ET-70
 150 mm



Ø Est. 5 mm
 Ø Int. 2,5 mm

- ET-45-1 | Ø 3 mm
- ET-45-2 | Ø 3 mm

KILLIAN
ET.2022-71
 145 mm

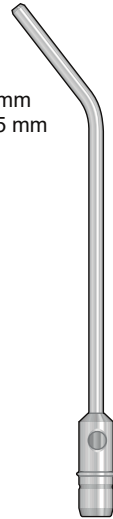

PELTON-CRANE
ET.2022-72
 160 mm

• SUCTION TUBES

Ø 1 mm



OL-22
50 mm

Ø 2 mm



OL-23
50 mm

Ø 3 mm



OL-24
50 mm

Ø 3 mm

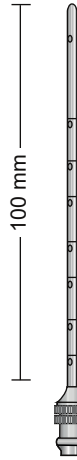

FRAZIER
GF-190

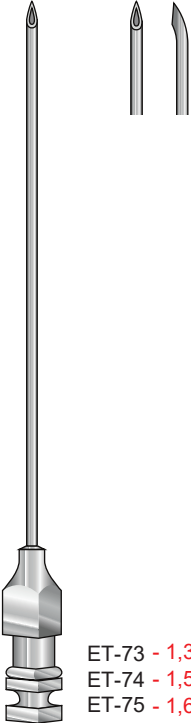

ET-73 - 1,30 x 80 mm
ET-74 - 1,50 x 80 mm
ET-75 - 1,65 x 80 mm

TUOHY

ET.2022-73 / ET 75

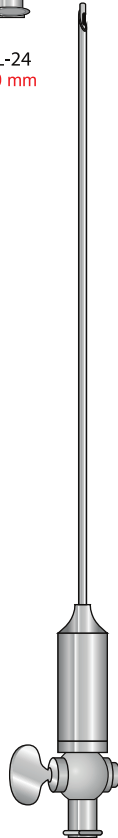

ET-76 120 mm
ET-77 150 mm

VERRES

ET.2022-76 / ET 77

SCHM
OL-3
150 m

Ø 1 mm
Ø 1,5 mm
Ø 3 mm



HEPARIN

OL-07 60 mm
OL-25 80 mm

Ø 3 mm



ET.2022-78

75 mm

Ø 4 mm



ET.2022-79

95 mm

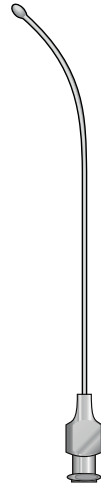

ET.2022-80

90 mm

Ø 3 mm



**SCHMID
ET-30**
150 mm

Ø 4 mm



**SCHMID
ET-31**
150 mm

Ø 5 mm

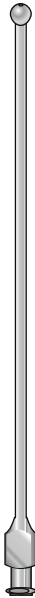

**SCHMID
ET-32**
150 mm

Ø 6 mm



**SCHMID
ET-33**
150 mm

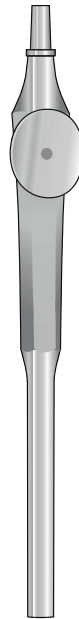

**LUER-LOCK
ET-34**
120 mm



**LUER-LOCK
ET-35**
65 mm

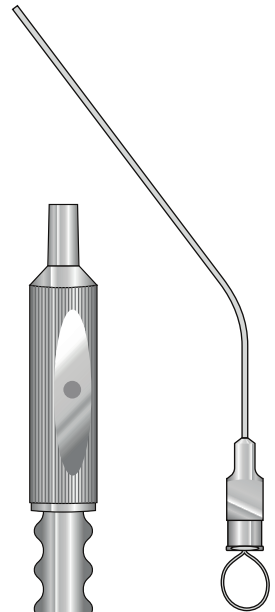

**ROSEN
ET-36**
95 mm



“Endo Tech Instruments” is Renowned manufacturer in arena making surgical instruments since 1990. This is our family business and we are in 2nd generation to provide manufacturing services. we certainly have the potential to fulfill the requirement from our valued customer.

Quality Assurance Management

We established a separate department called “Quality Assurance Management” who carefully watch all the processes concerning to quality.

Quality built surgical instruments according to customers’ requirements at competitive price.

Total customer satisfaction from first contract to delivery with best and honest services in the appropriate machinery, best method and suitable processes.



Al Muslim Street #5, Islam Naghar Road
Pacca Garah Sialkot 51310 Pakistan

info@endotech.com.pk
endotechinstrument@gmail.com

MOB: +92 333 87 20 804 PH: +92 52 4352088

endotech.com.pk | myendotech.com

