



INSPIRING
CONFIDENCE IN

HEALTH CARE



Care with Trust...
ENDO TECH
GROUP OF INDUSTRIES



Al Muslim Street #5 Islam Nagar
Road Pacca Garah
Sialkot - 51310 Pakistan



+92-52-4352088
+92-333-8720804



info@endotech.com.pk
endotechinstrument@gmail.com



www.endotech.com.pk



COMPANY HISTORY

“ Endo Tech Instruments “ is enowed manufacturer in arena making surgical instruments since 1990. This is our family business and we are 2nd generation to provide manufacturing servies. we certainly have the potential to fulfill the requirement from our valued customer.

The president of ENDOTECH Instruments, Dennis R. Scanlan III and his sons, bring with them a lifetime of knowledge about the world of surgical instruments. This insight allows them to better understand the needs of our customers in a way most other instrument companies are unable to do.

BUSINESS ARENA

“ Endo Tech Instruments “ is the growing Medical Instruments Manufacturing Company. We offer to all the customers just let us know your designs, drawing, pictures & ideas to manufacture instruments we have capability to convert your ideas into real instruments

OUR VALUES

Quality consciousness is one of our major concerns as we always keep the quality of our products in our mind as per the requirement of the customer and in doing so we try to deliver the most competitive products. Endo Teach achieves superior client focus by being well aware of all customer requirements and provides them consistently high quality products. We take our commitments with our valued customers very seriously by maintaining our promises regarding the Raw-Material, Product Quality, Lead Time, and Price as the focal point. Our aim is the continuous improvement in the quality of our products, and we are also engaged in R&D to enhance excellent quality products.

OUR MISSION

Our mission is to fulfil the needs of our customers by providing them quality products and to conduct our business activities in a way that our customers, employees and all stakeholders should be uniformly benefited.

QUALITY ASSURANCE MANAGEMENT

We established a separate department called “Quality Assurance Management” who carefully watch all the processes concerning to quality.







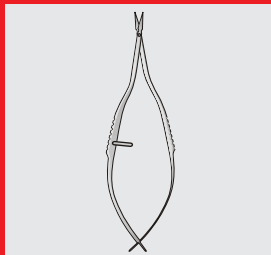

OUR STRATEGY

Our strategy is based on the concepts of Consistency, Continuous Improvement and Superior Product Quality. As we have faith in consistency, we can never compromise in the quality of our products through which we make healthy relationship with our valued customers. Our clients can be very confident that the product quality will not significantly change between one order and the next. At Endo Teach, by our skilled and well experienced labor we produce high quality instruments and we also sincerely work with our clients to be better aware of their needs. Endo Teach believes in superior product quality, and assures its clients that regarding its commitment to provide the highest quality good to its customers for their benefits.

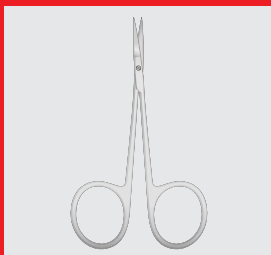
OUR VISION

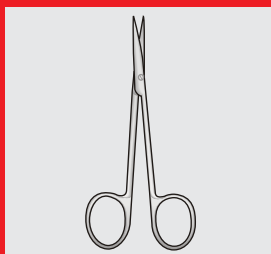
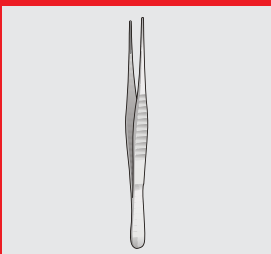
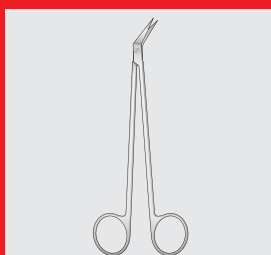
Our vision is to bring Endo Teach as the leading ENT and surgical instruments provider in highly professional way by providing its consumers high quality instruments and by playing an active and important role in market.

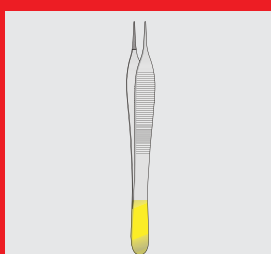
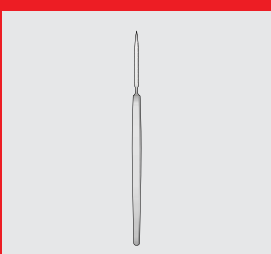
Table of Contents

01		MICRO SCISSOR	45		THUMB AND TISSUE FORCEPS
05		DELICATE SCISSOR	47		EAR FORCEPS
11		OPERATING SCISSORS	49		ATRAUMATIC TISSUE FORCEPS
27		VASCULAR SCISSORS	51		CILIA FORCEPS
29		TISSUE FORCEPS	53		SCALPEL BLADES & HANDLES
37		DELICATE FORCEPS			

01

Micro Scissors

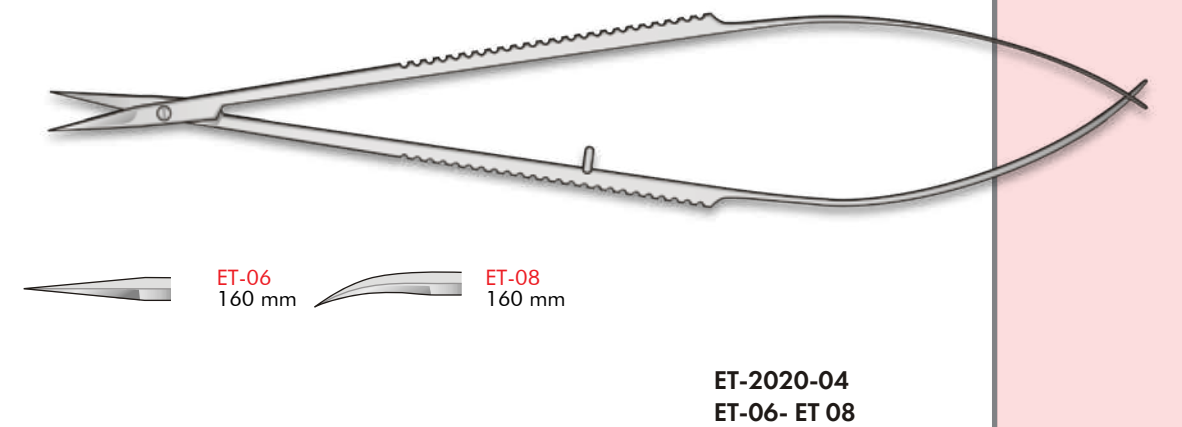
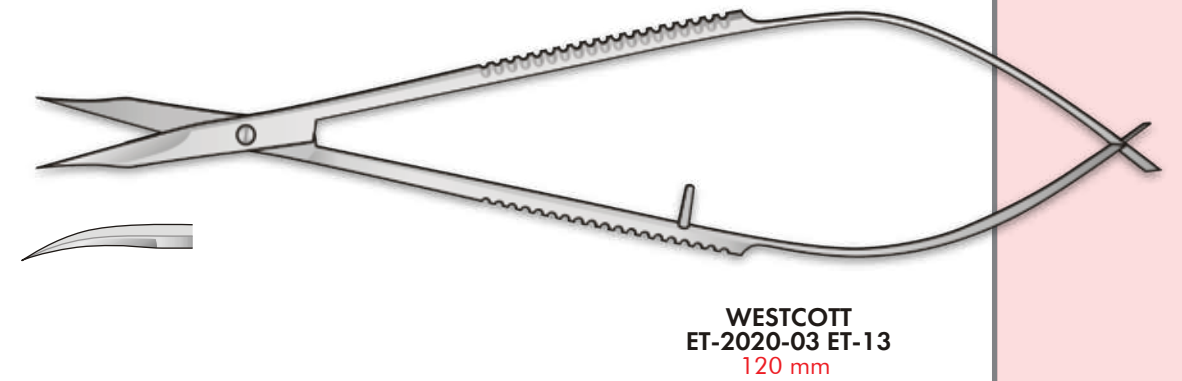
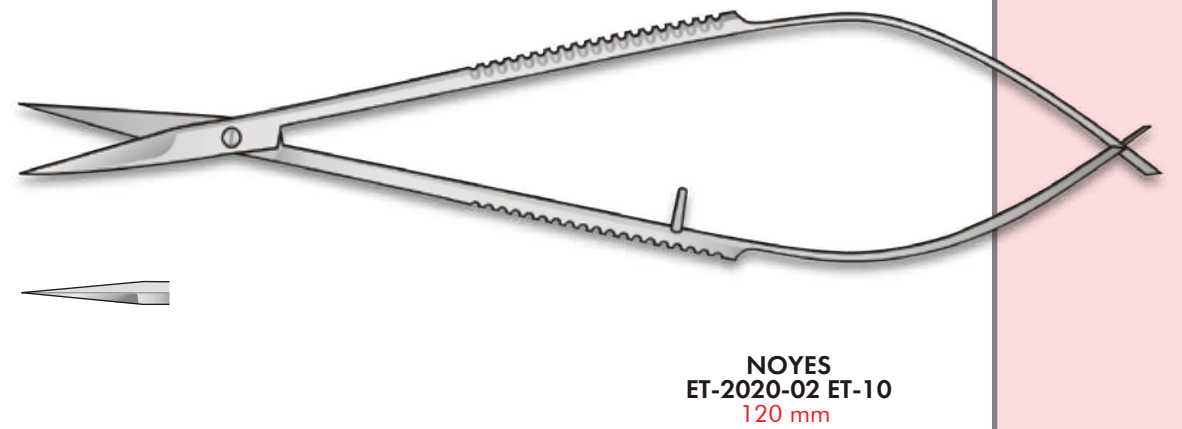
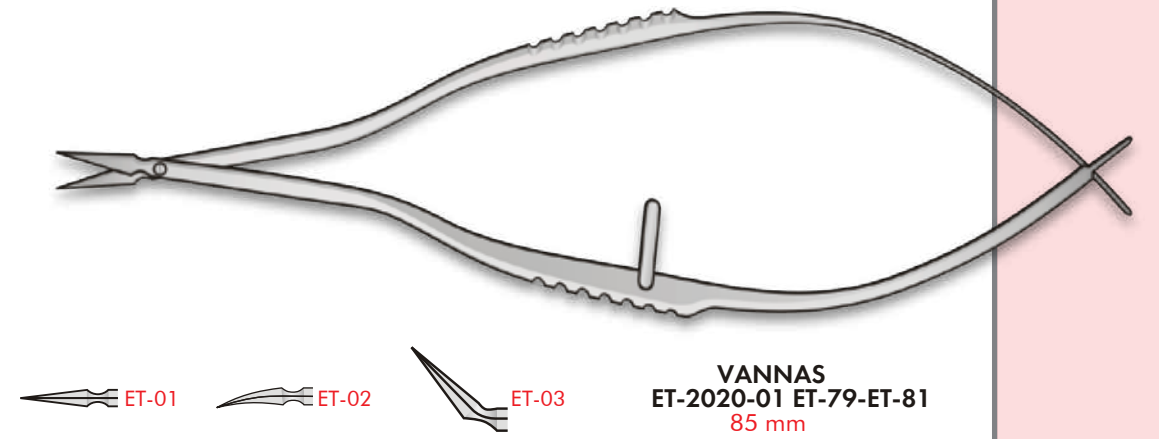
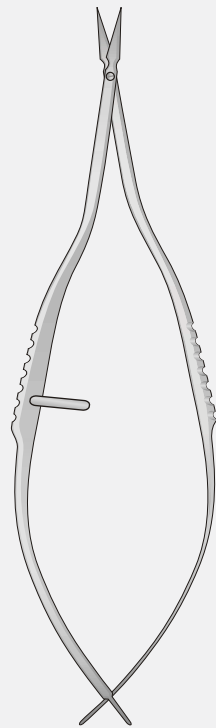

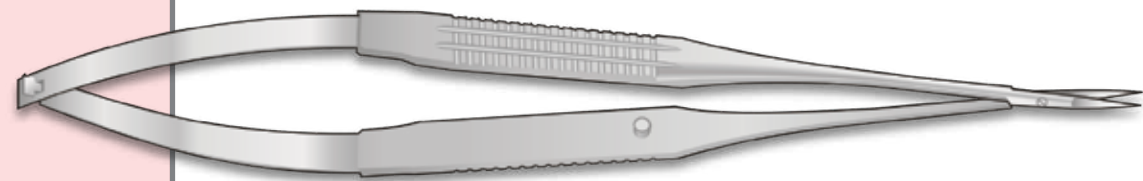

YASARGIL
ET-2020-05 ET-186
180 mm

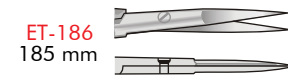

ET-186
185 mm

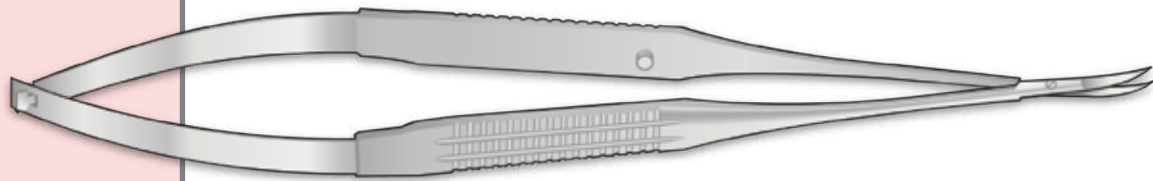

JACOBSON
ET-2020-06 FD-187
185 mm

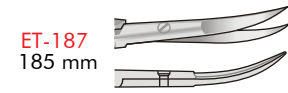

ET-187
185 mm

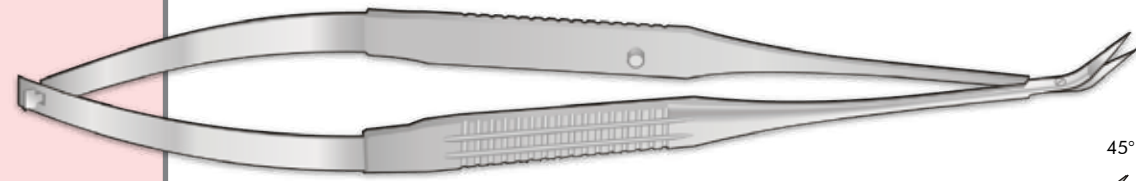

FEICHENFELD
ET-2020-07 ET-123
115 mm

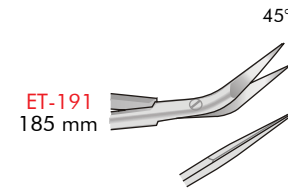

ET-191
185 mm



YASARGIL
ET-2020-08 ET-408
225 mm



YASARGIL
ET-409

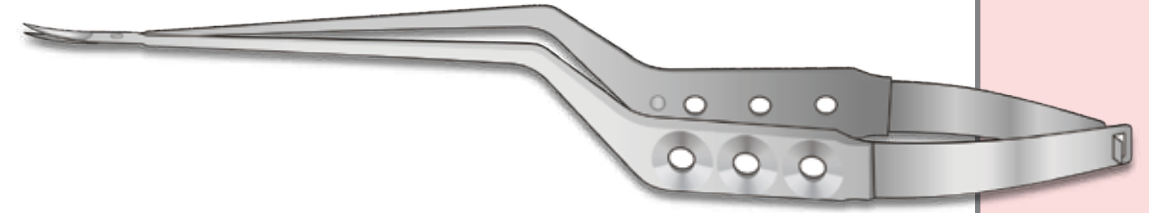

YASARGIL
ET-2020-09 ET-412
245 mm

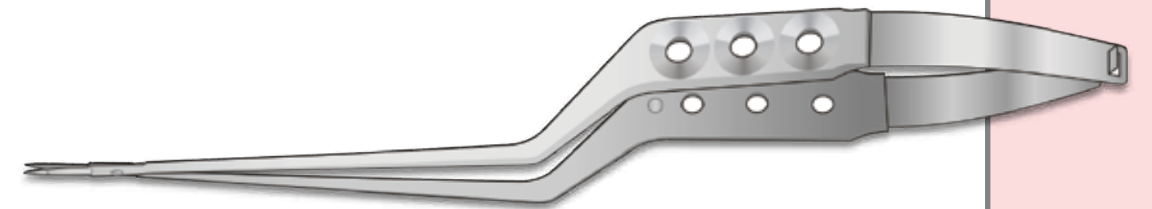

VANNAS
ET-2020-10 ET-410
225 mm

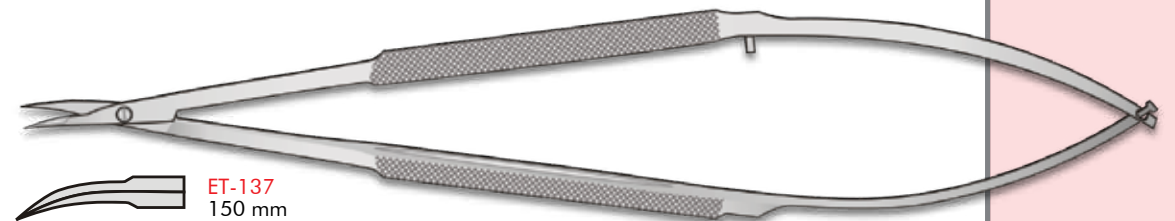

VANNAS
ET-2020-11 ET-410
225 mm



ET-137
150 mm



ET-138
150 mm



BROCK
ET-2020-12 ET-221
150 mm

05

Delicate Scissors

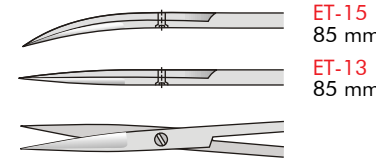
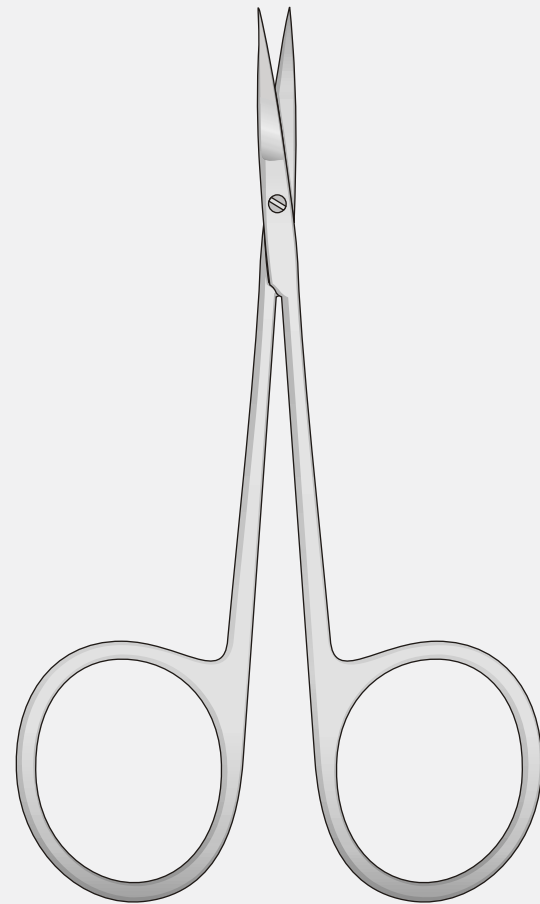

ET-15
85 mm

ET-13
85 mm

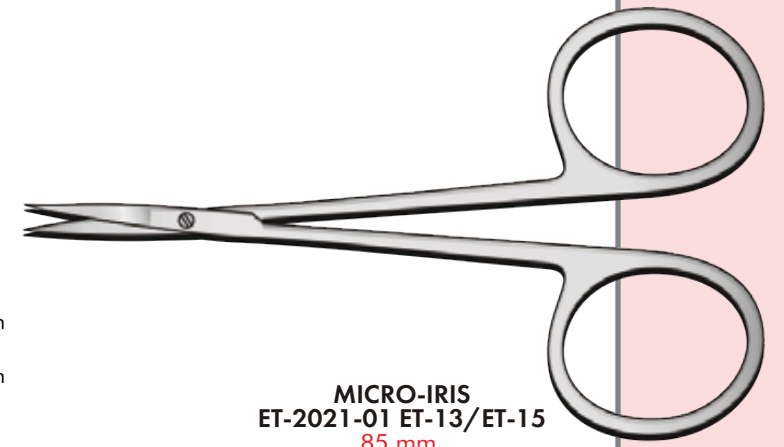

MICRO-IRIS
ET-2021-01 ET-13/ET-15
85 mm

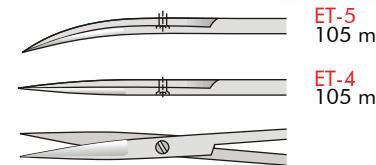

ET-5
105 mm

ET-4
105 mm

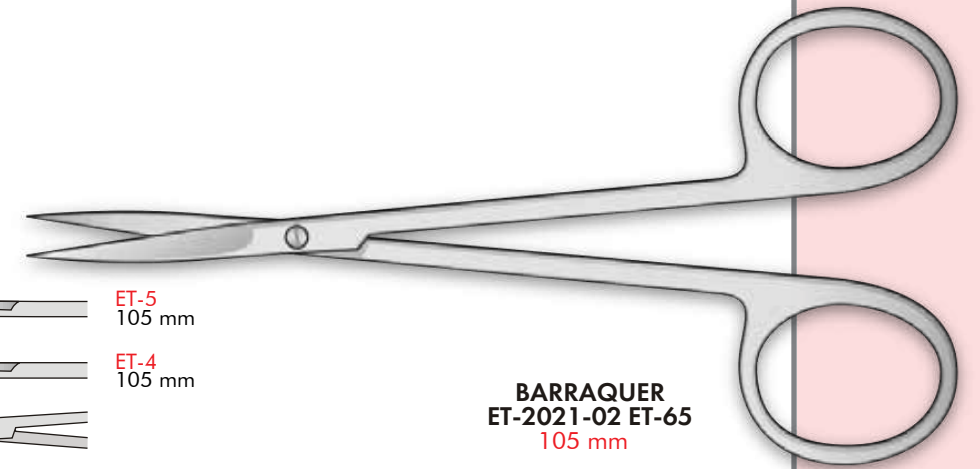

BARRAQUER
ET-2021-02 ET-65
105 mm

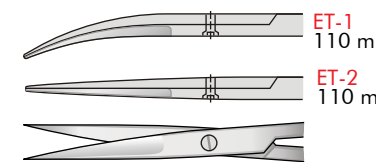

ET-1
110 mm

ET-2
110 mm

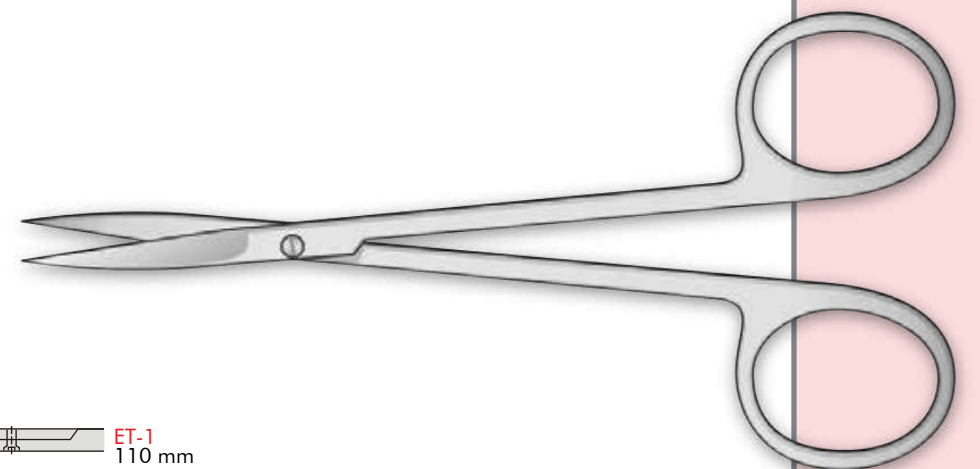

IRIS
ET-2021-03 ET-1-ET-2
110 mm

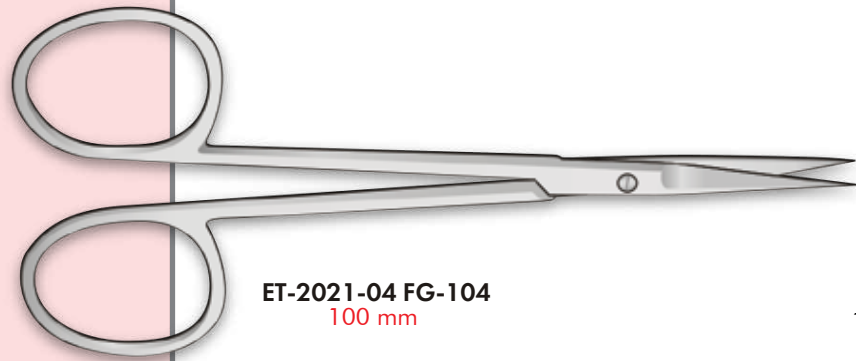

ET-2021-04 FG-104
100 mm

ET-104
100 mm

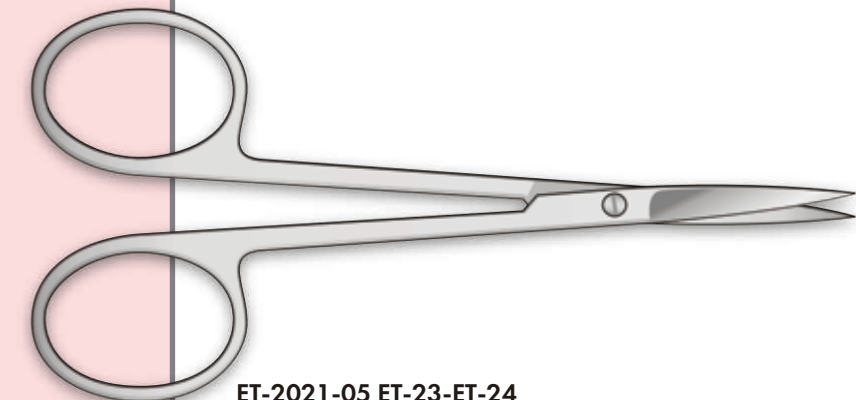
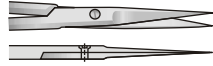

ET-2021-05 ET-23-ET-24
110 mm

ET-23



ET-24

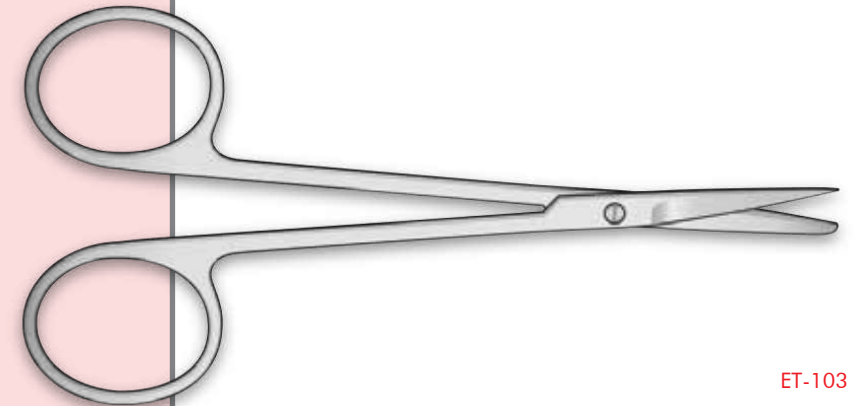

ET-2021-06 ET-103-ET-105
110 mm

ET-103



ET-105

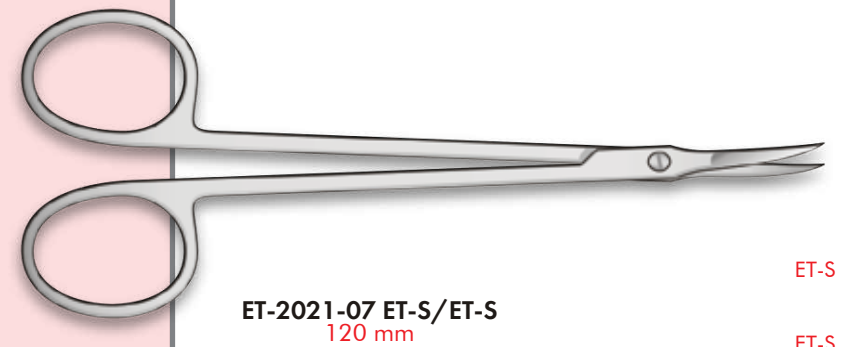

ET-2021-07 ET-S/ET-S
120 mm

ET-S



ET-S

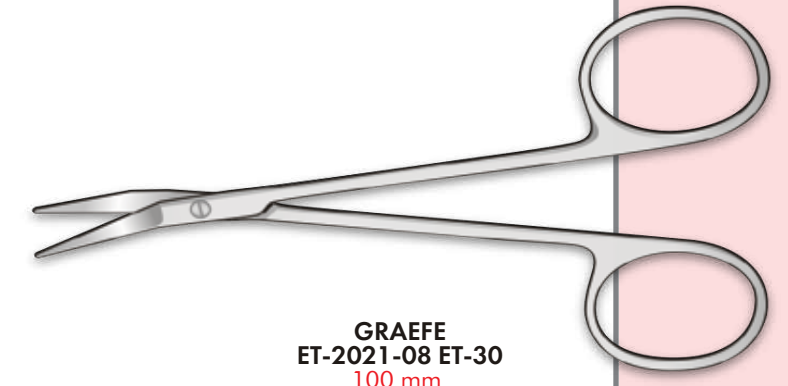

GRAEFE
ET-2021-08 ET-30
100 mm

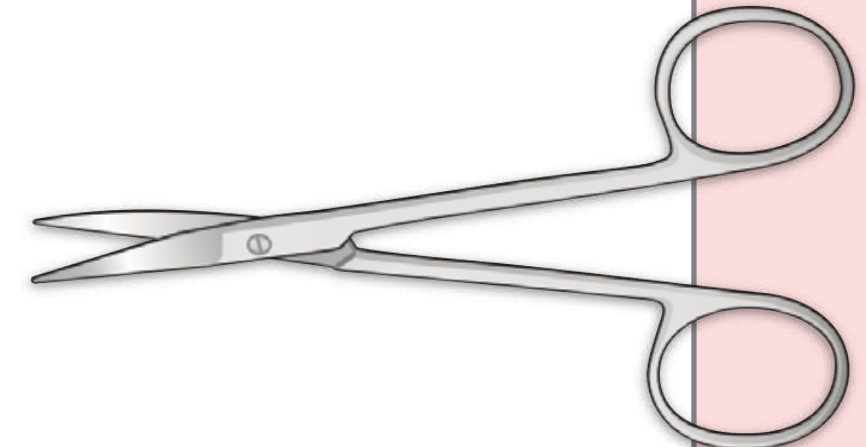
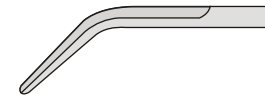

COTTLE-MASING
ET-2021-09 ET-108-ET-109
105 mm

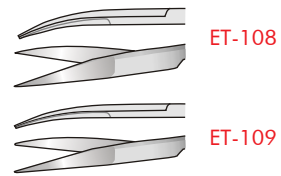

ET-108

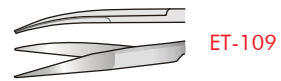

ET-109

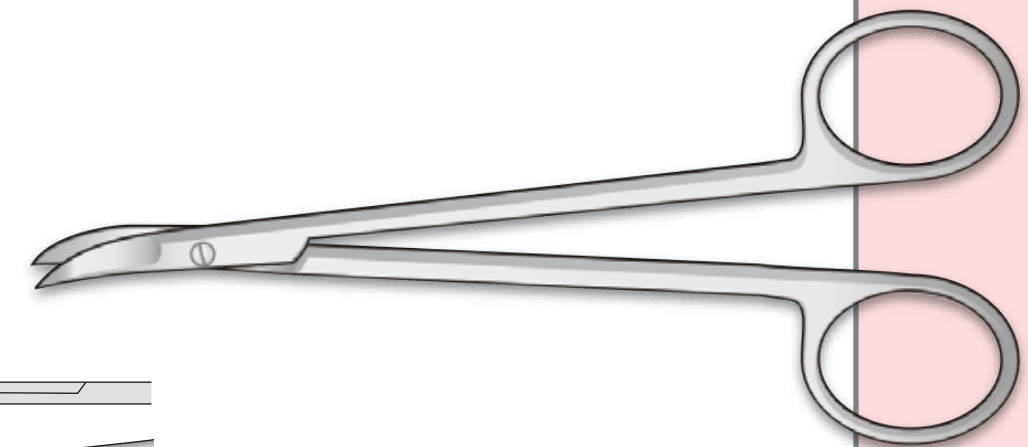

CHADWICK
ET-2021-10 ET-39
115 mm

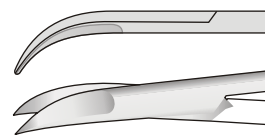



GOLDMAN-FOX S FORM
ET-2021-11
130 mm

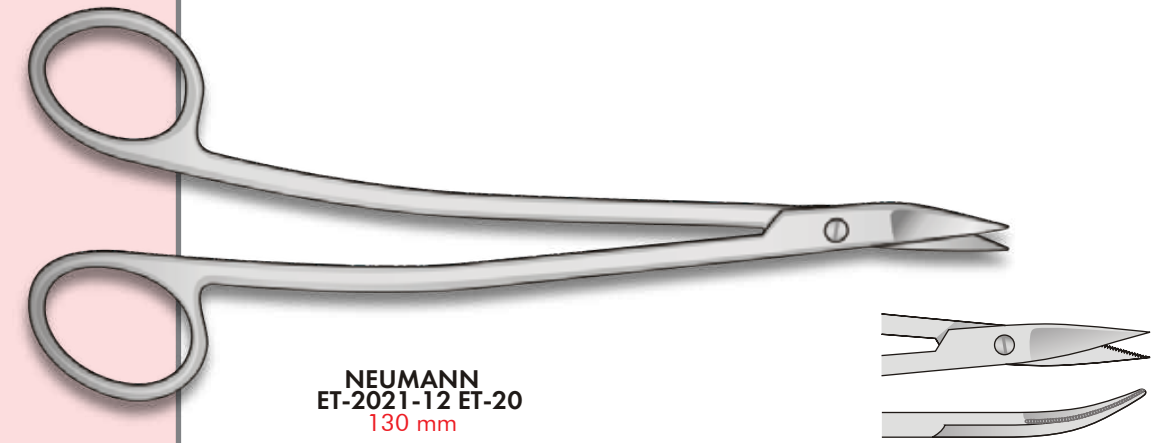

NEUMANN
ET-2021-12 ET-20
130 mm

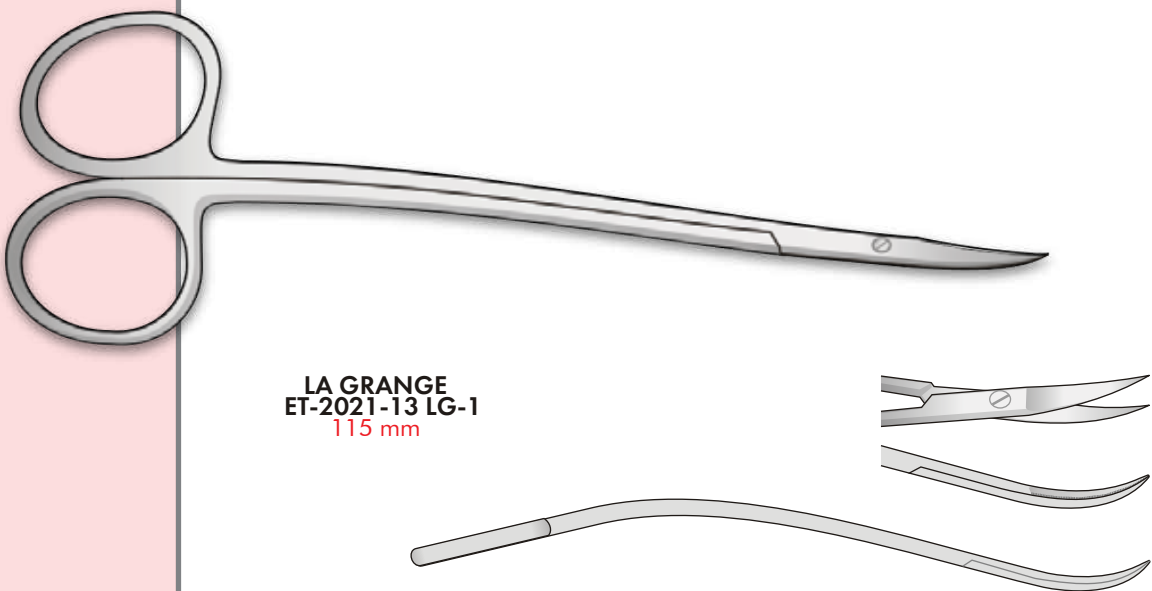

LA GRANGE
ET-2021-13 LG-1
115 mm



LA GRANGE
ET-2021-14 ET-6
155 mm

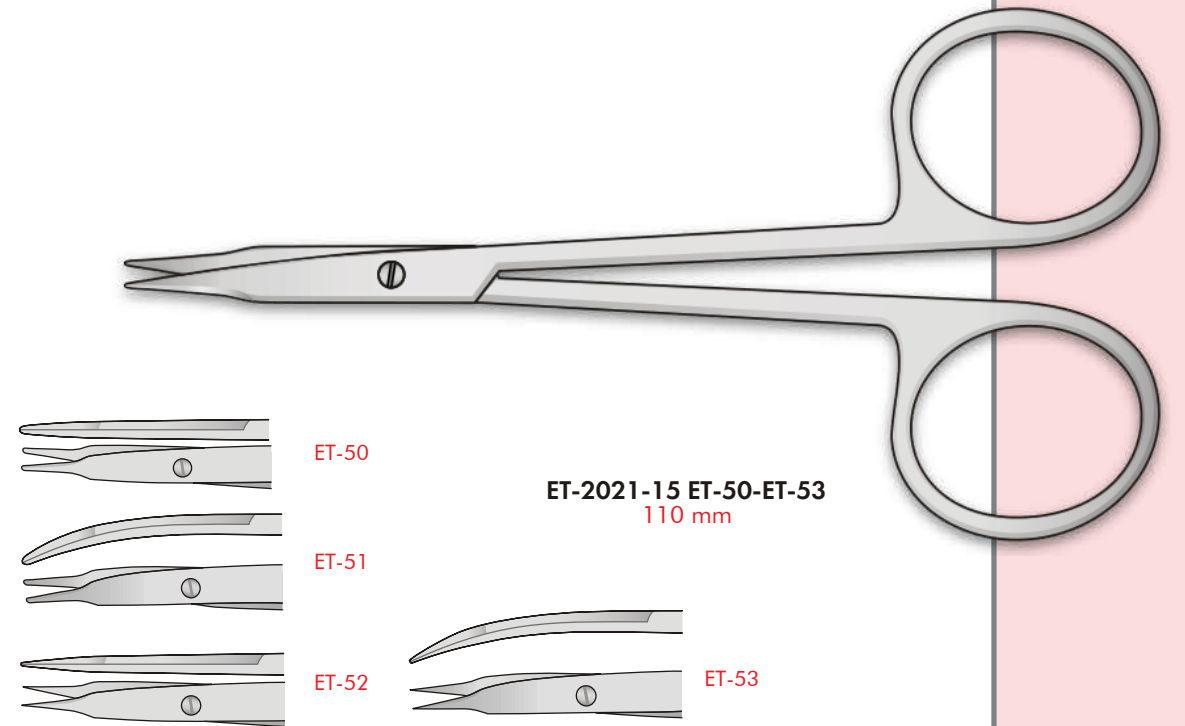

ET-2021-15 ET-50-ET-53
110 mm

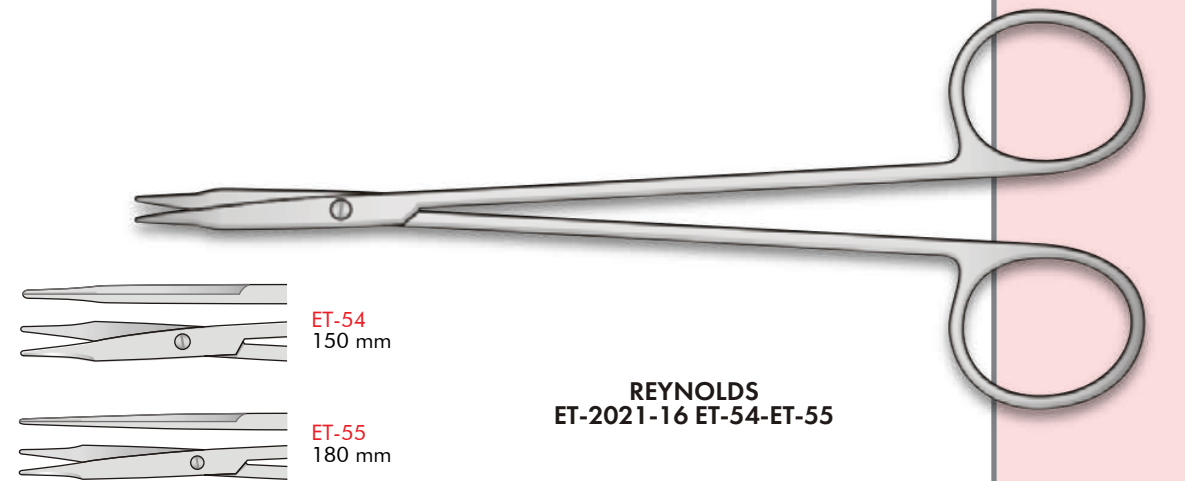

REYNOLDS
ET-2021-16 ET-54-ET-55

Operating Scissors

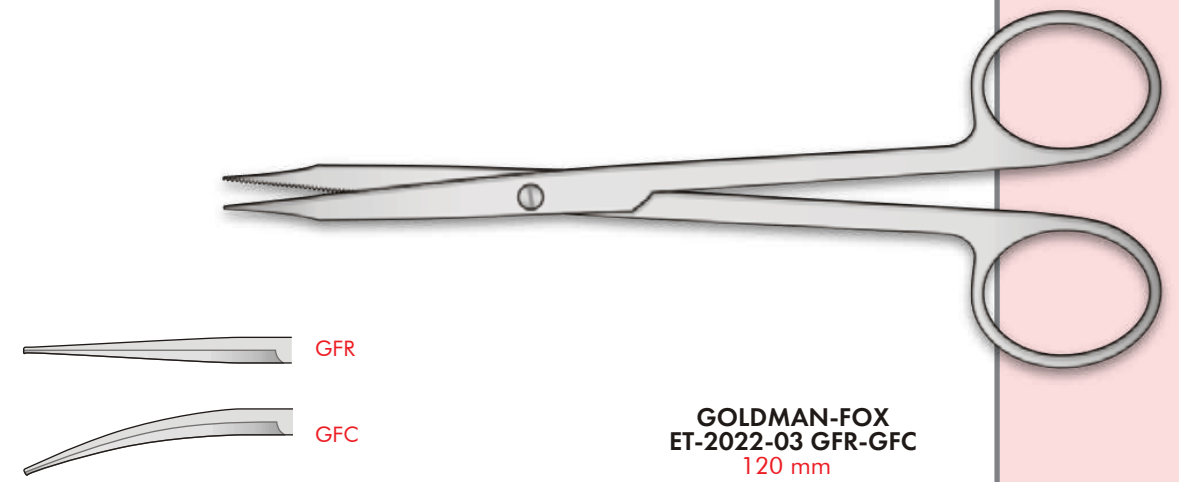
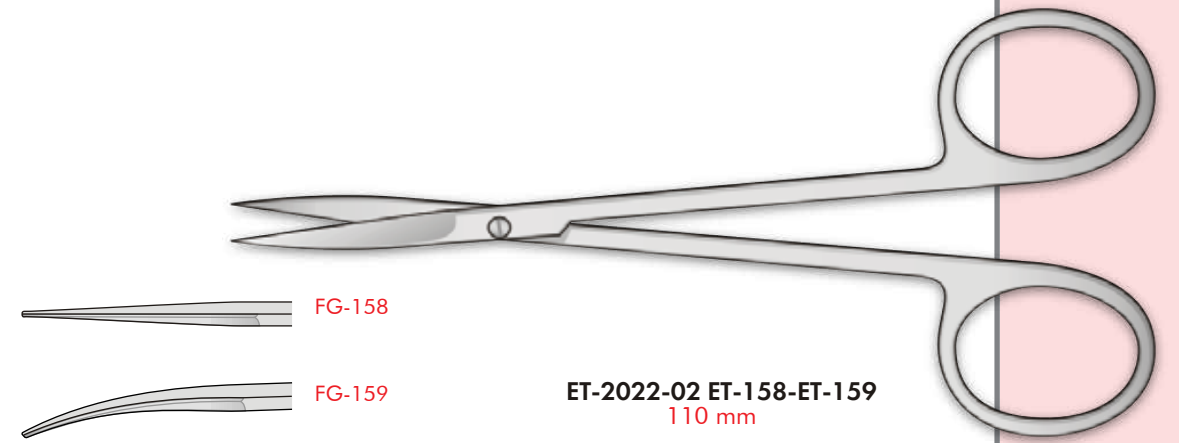
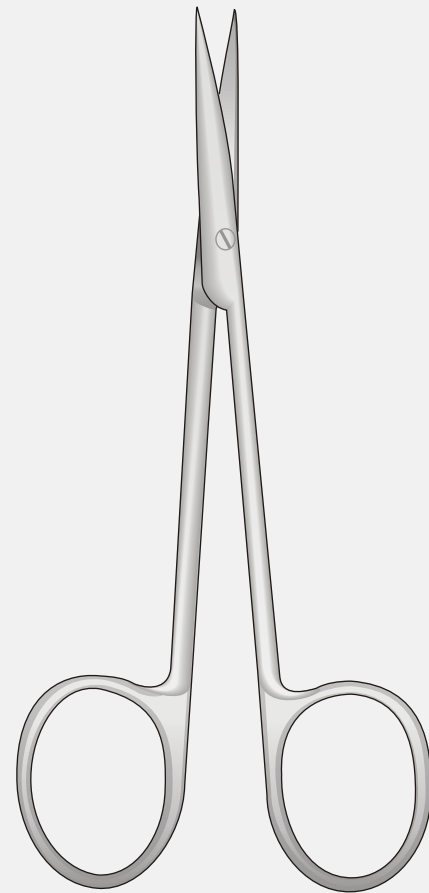

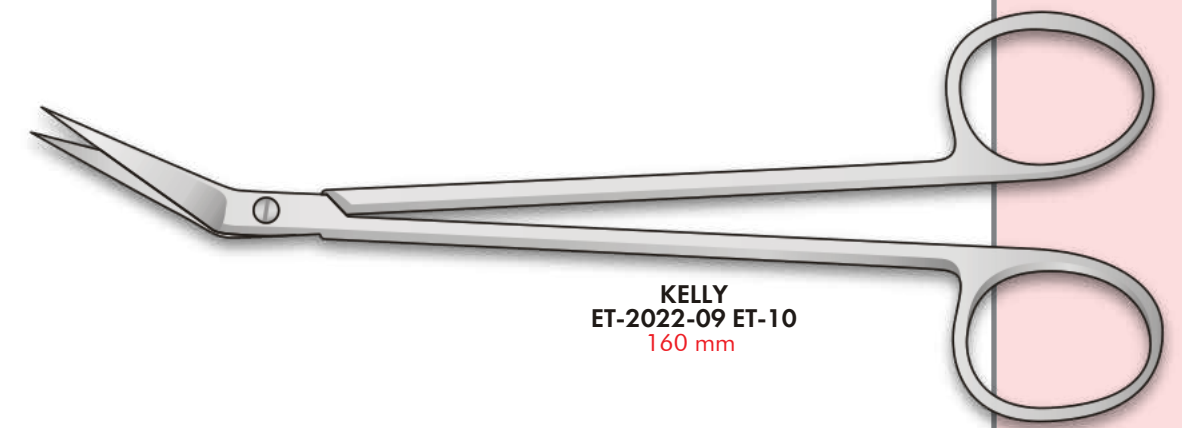
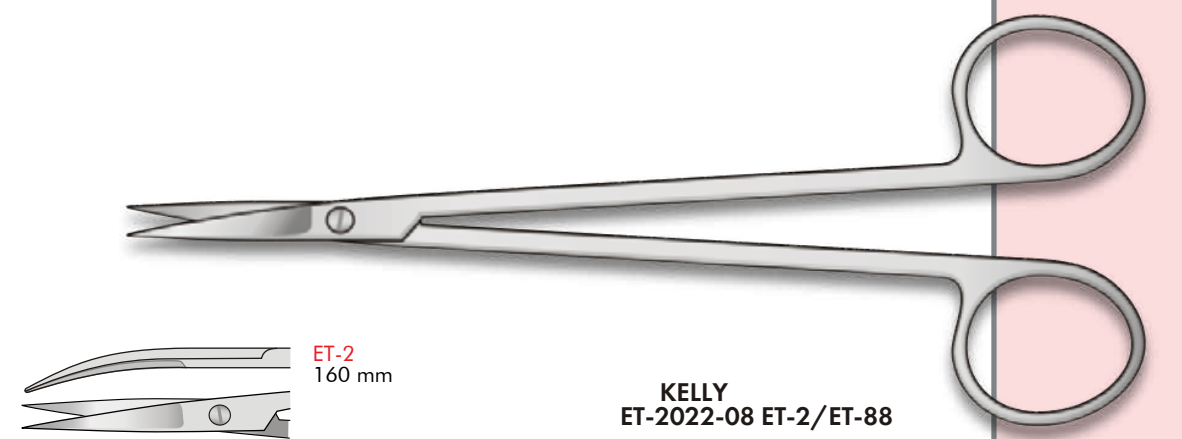
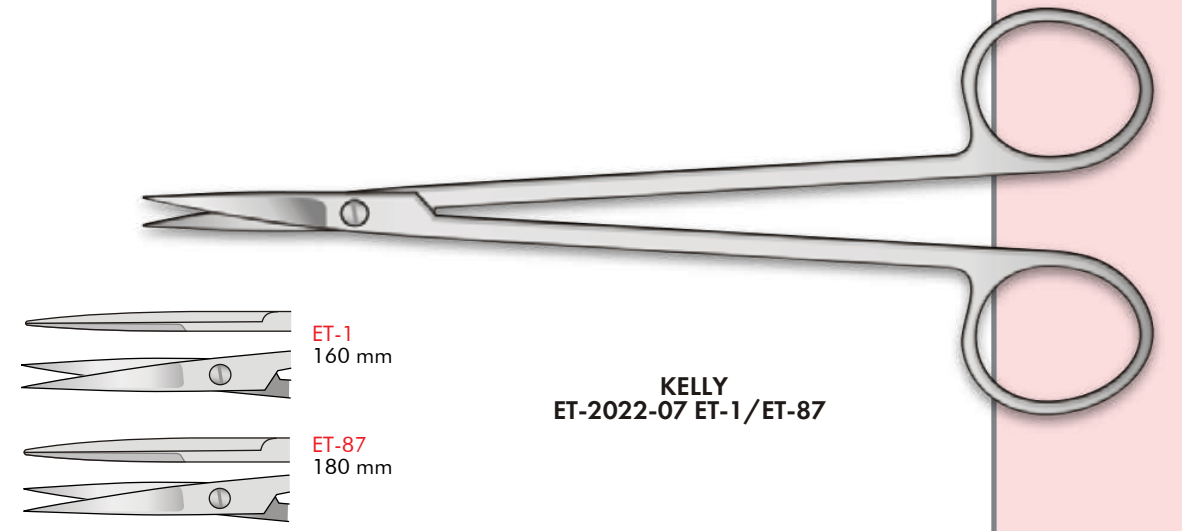
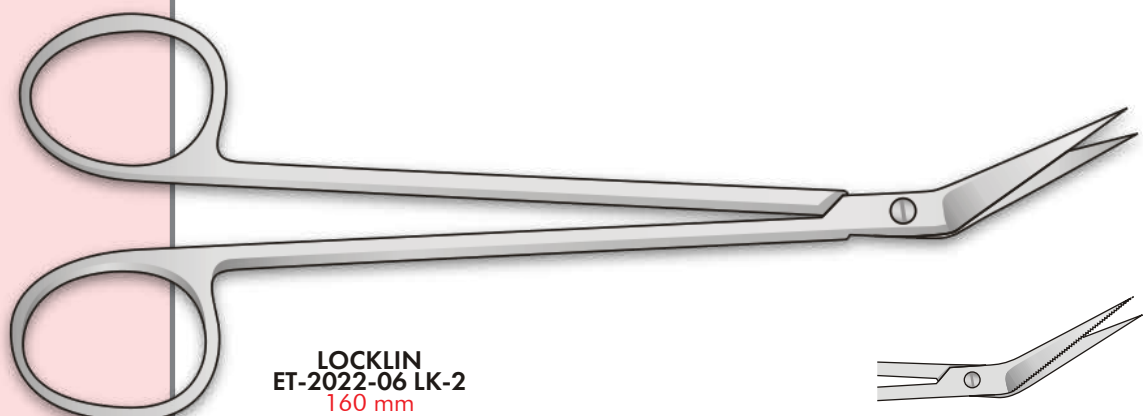
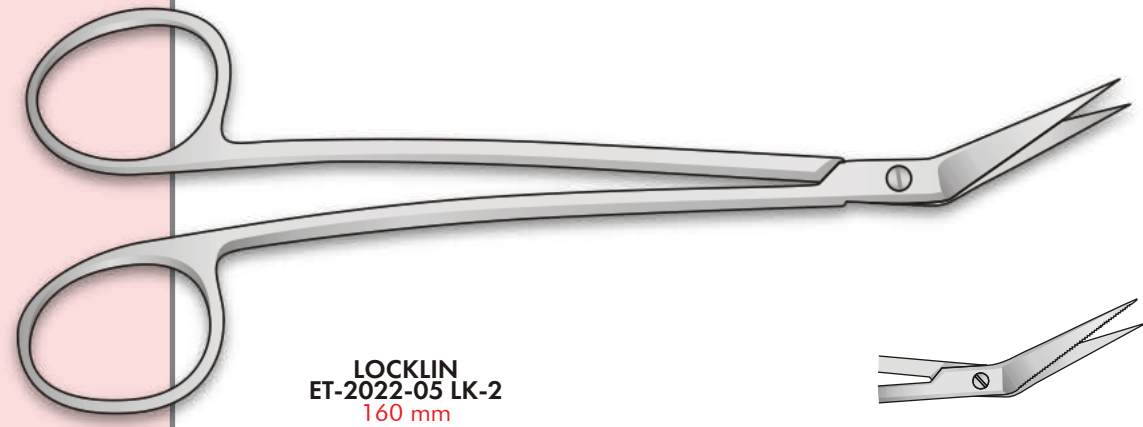
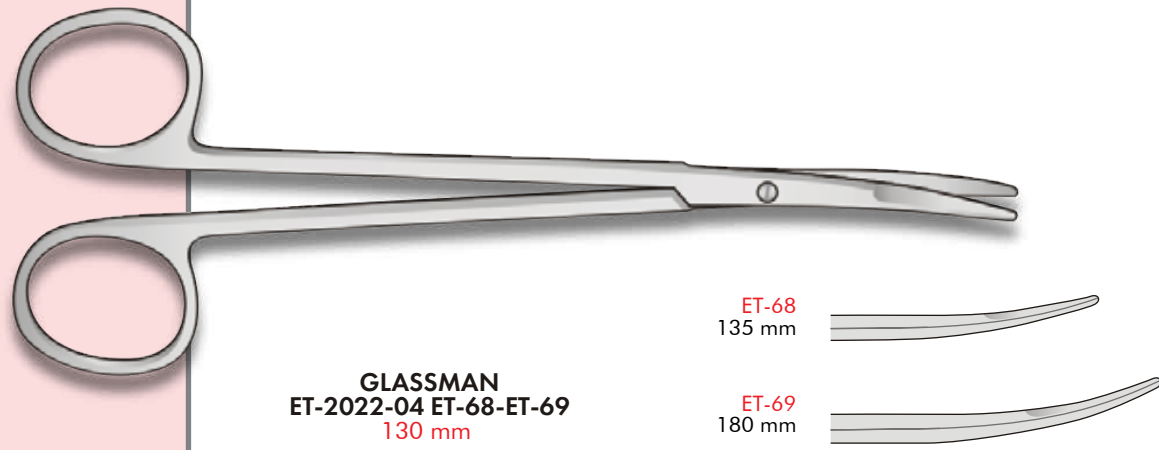

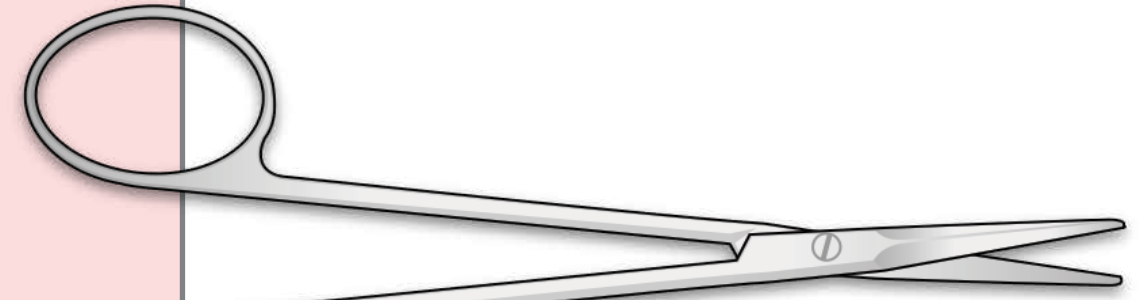

GORNEY
ET-2022-10 ET-125/ET-127

ET-125
125 mm

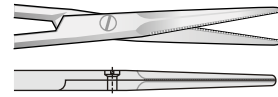

ET-126
195 mm

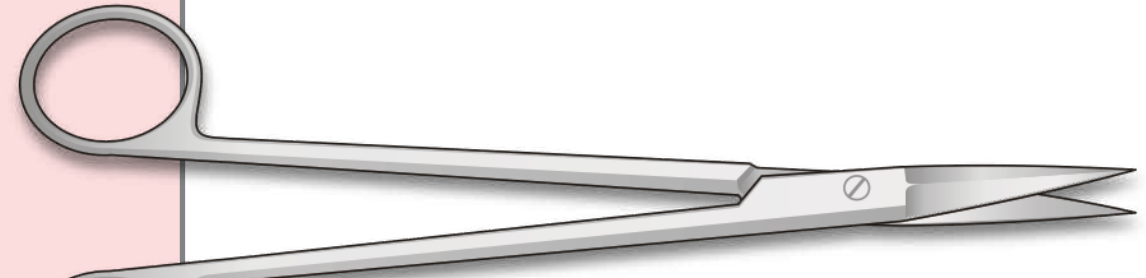
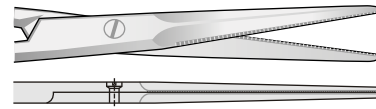

ET-2022-11 ET-128
185 mm

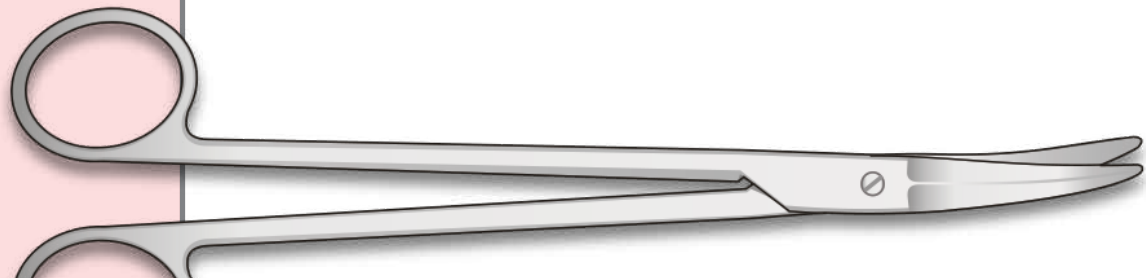
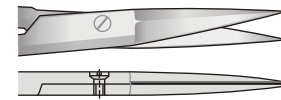

ET-2022-12 ET-10
185 mm

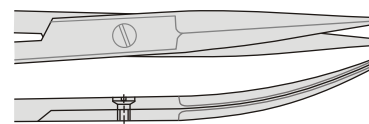

ET-132

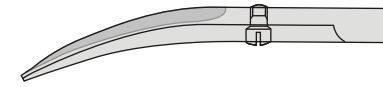

ET-2022-13 ET-132-ET-133
190 mm

ET-133



STRULLY
ET-2022-14 ET-106
220 mm

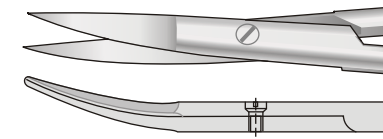

STRULLY
ET-2022-15 ET-107
220 mm

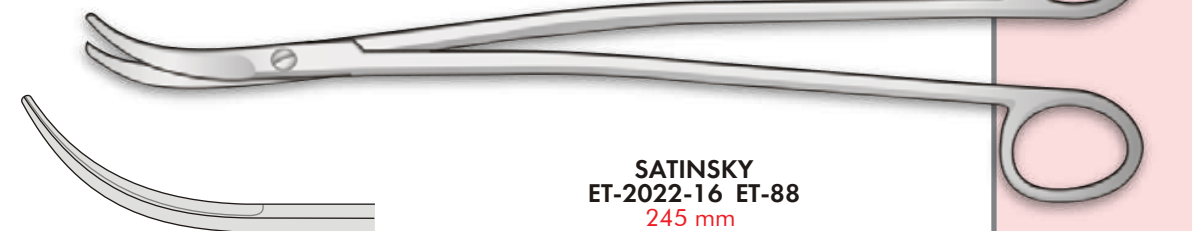
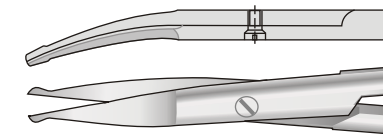

SATINSKY
ET-2022-16 ET-88
245 mm

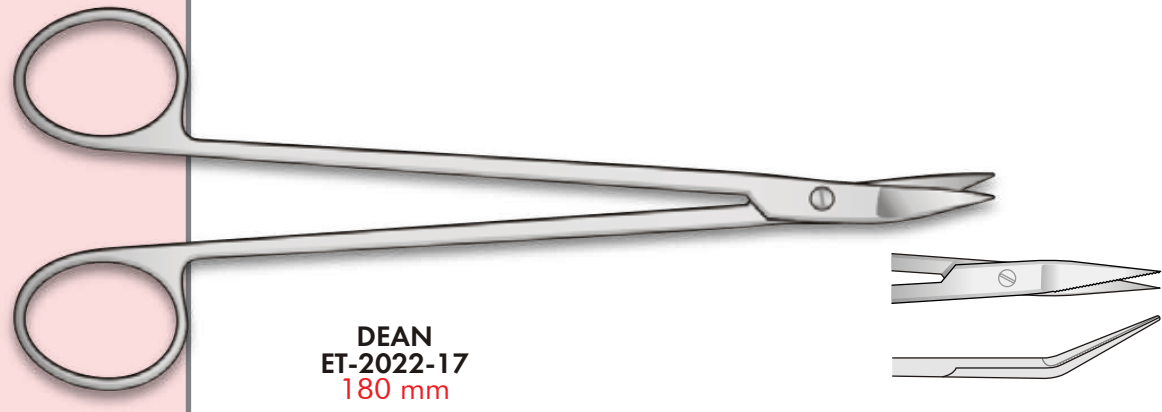

DEAN
ET-2022-17
180 mm

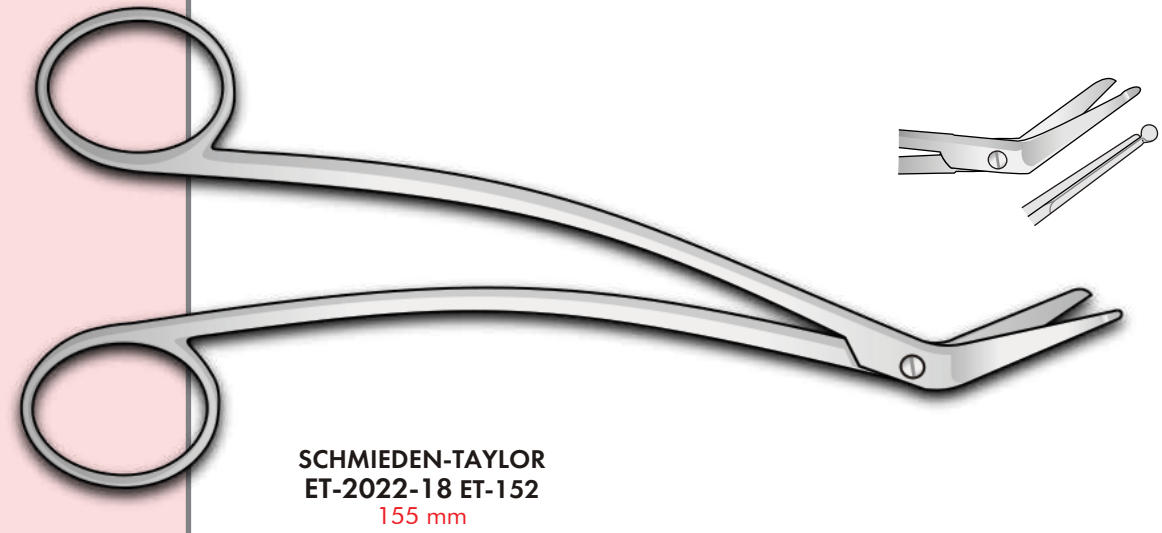

SCHMIEDEN-TAYLOR
ET-2022-18 ET-152
155 mm

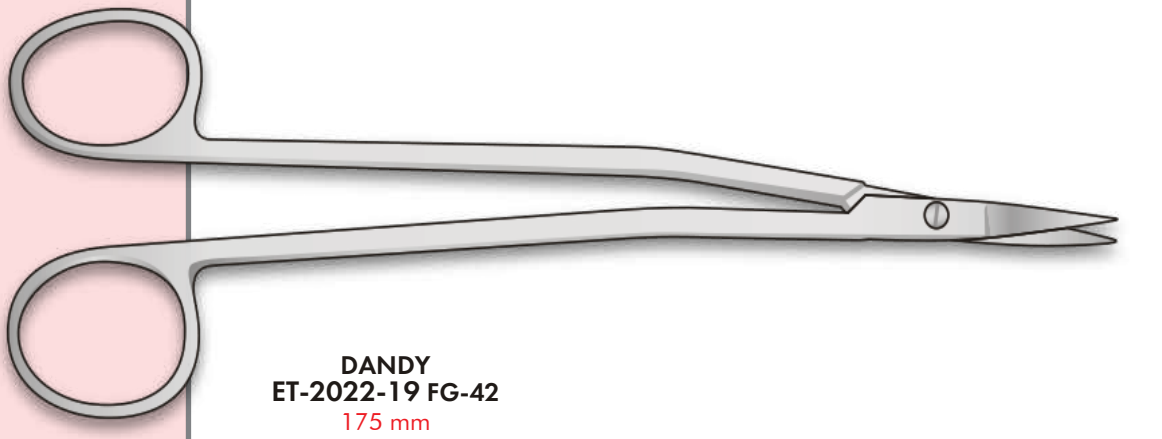

DANDY
ET-2022-19 FG-42
175 mm

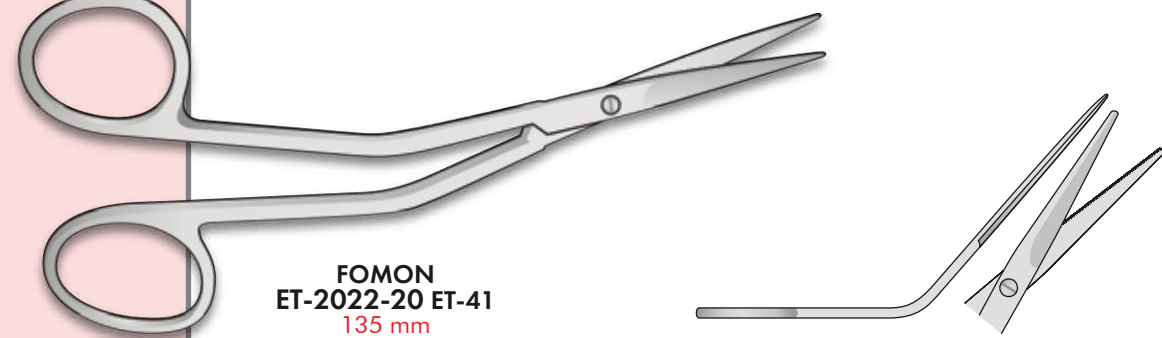

FOMON
ET-2022-20 ET-41
135 mm

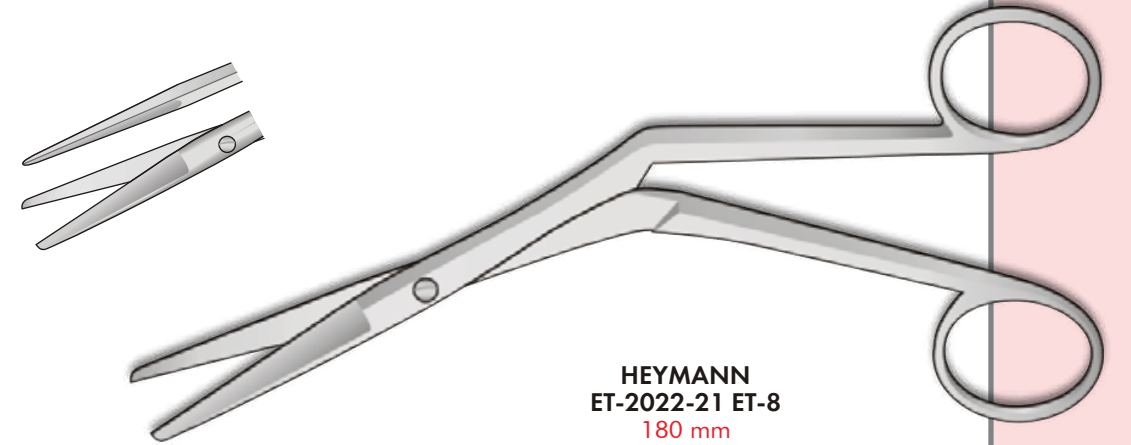

HEYMANN
ET-2022-21 ET-8
180 mm

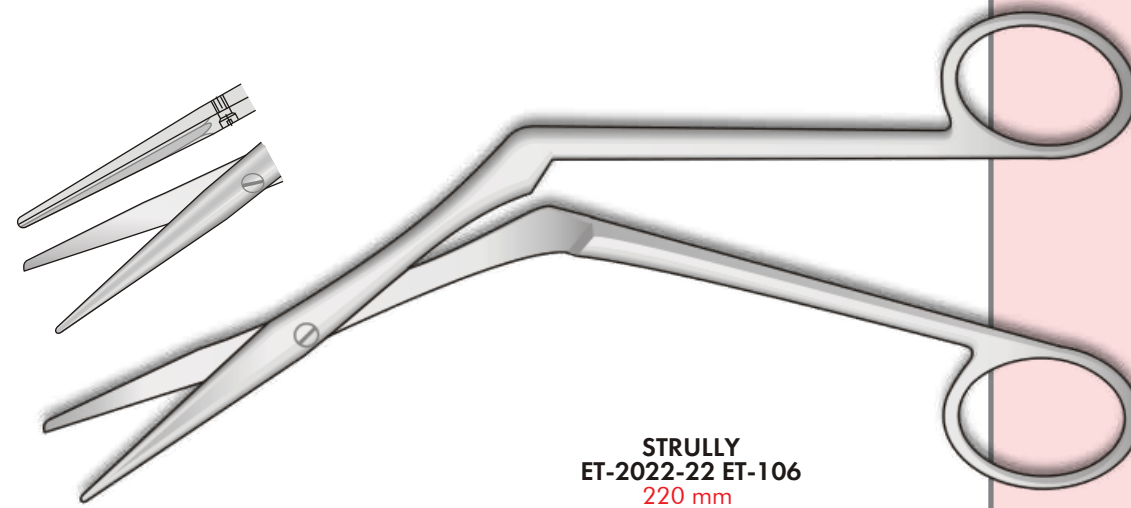

STRULLY
ET-2022-22 ET-106
220 mm

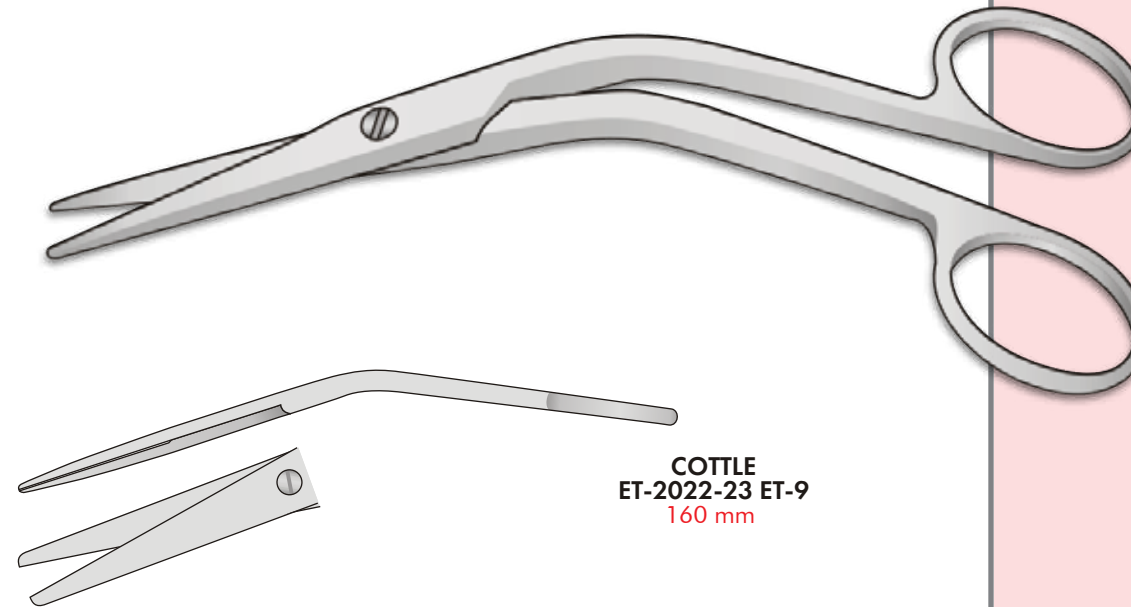

COTTLE
ET-2022-23 ET-9
160 mm



ET-19
230 mm

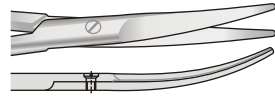

ET-18
230 mm

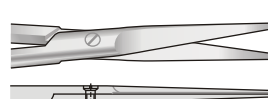

MAYO-HARRINGTON
ET-2022-24 ET-18-ET-19
230 mm



ET-15
200 mm

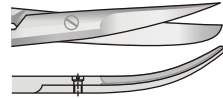

ET-14
200 mm

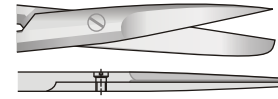

ET-17
230 mm



ET-16
230 mm



SIMS
ET-2022-25 ET-14-ET-17



ET-21
200 mm

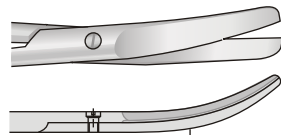

FM-20
200 mm

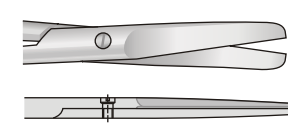

ET-23
230 mm



FM-22
230 mm

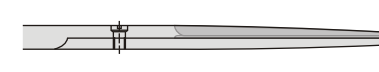

SIMS
ET-2022-26 ET-20-ET-23



ET-138
200 mm

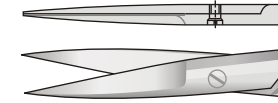

DIETRICH
ET-2022-27 ET-80-ET-84
190 mm



ET-139
210 mm

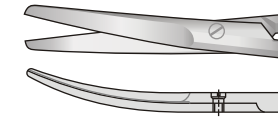

SIMS
ET-2022-28 ET-139

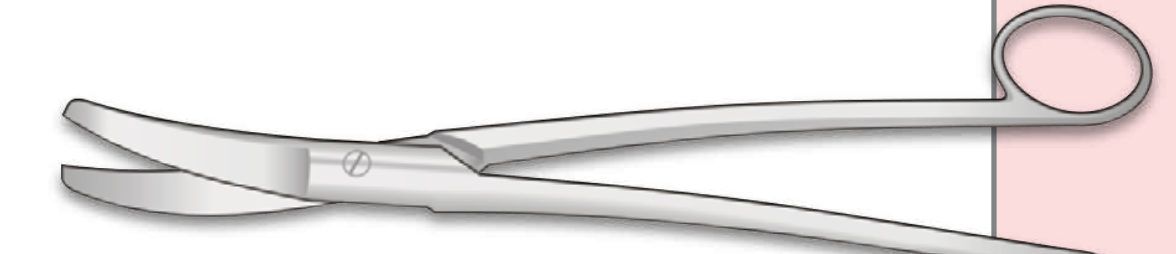

SIEBOLD
ET-2022-29 ET-144
245 mm

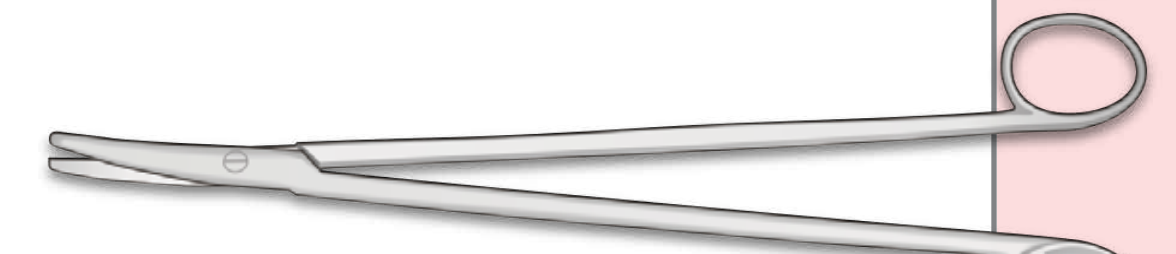

WELLER
ET-2022-30 ET-129
280 mm



KILNER
ET-2022-31 ET-58
115 mm

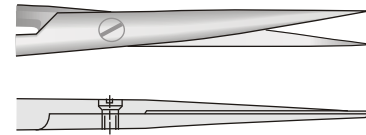

JAMESON-WERBER
ET-2022-32 ET-123
130 mm

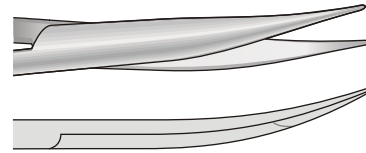

JAMESON
ET-2022-33 ET-124
145 mm

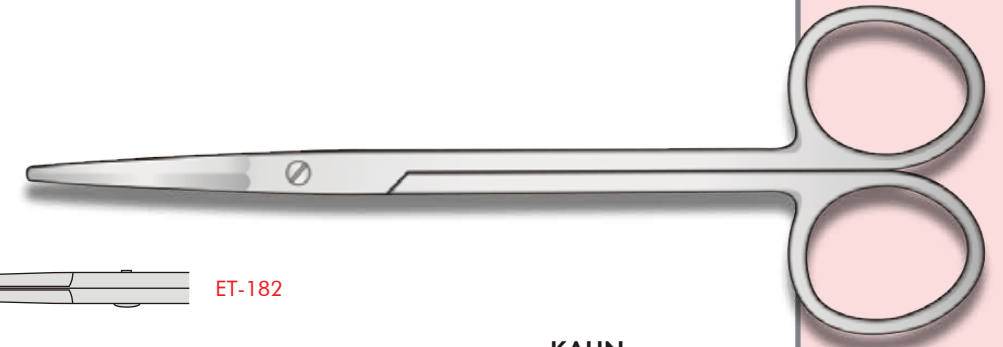
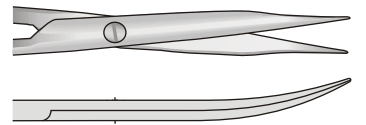

KAHN
ET-2022-34 ET-182-ET-183
145 mm

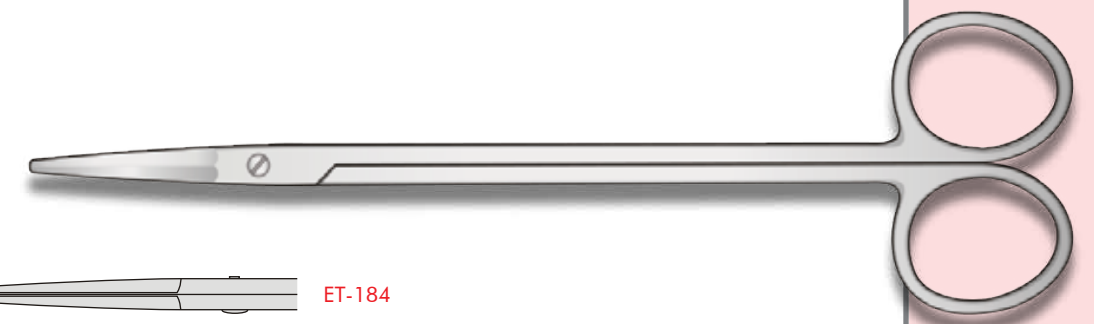
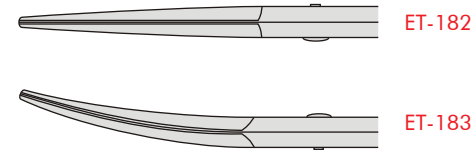

KAHN
ET-2022-35 ET-184 ET-185
180 mm

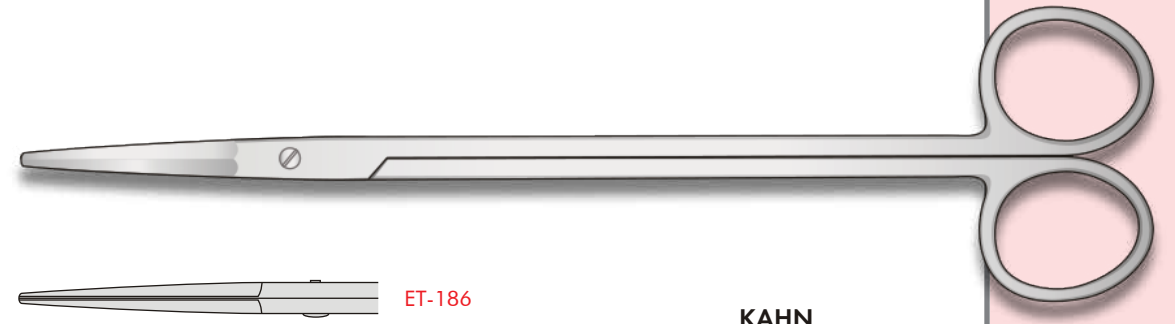
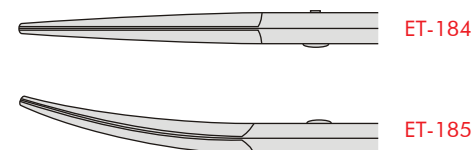

KAHN
ET-2022-36 ET-186 ET-187
205 mm

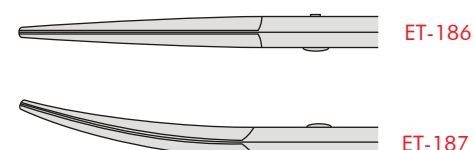

Super-cut™ scissors for gripping tissue and cutting interproximally

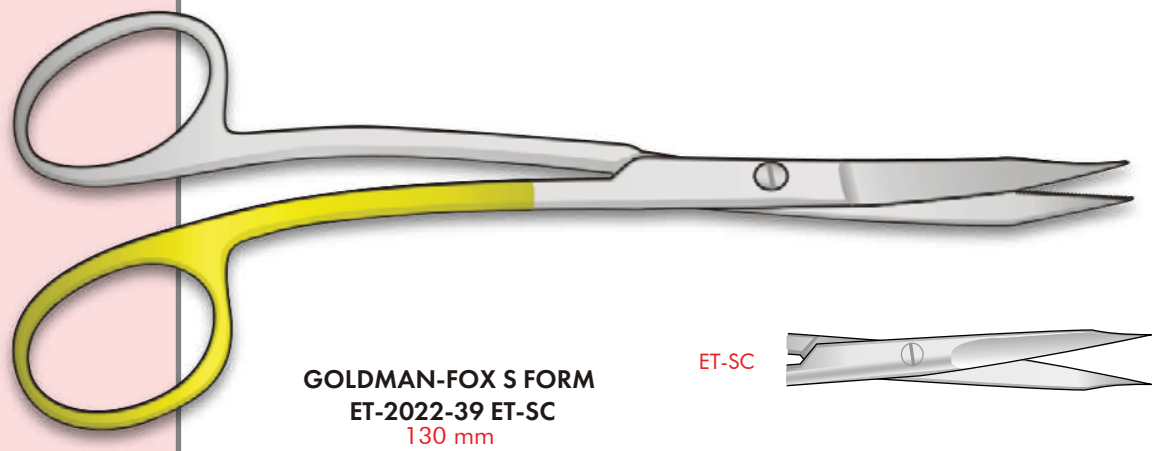
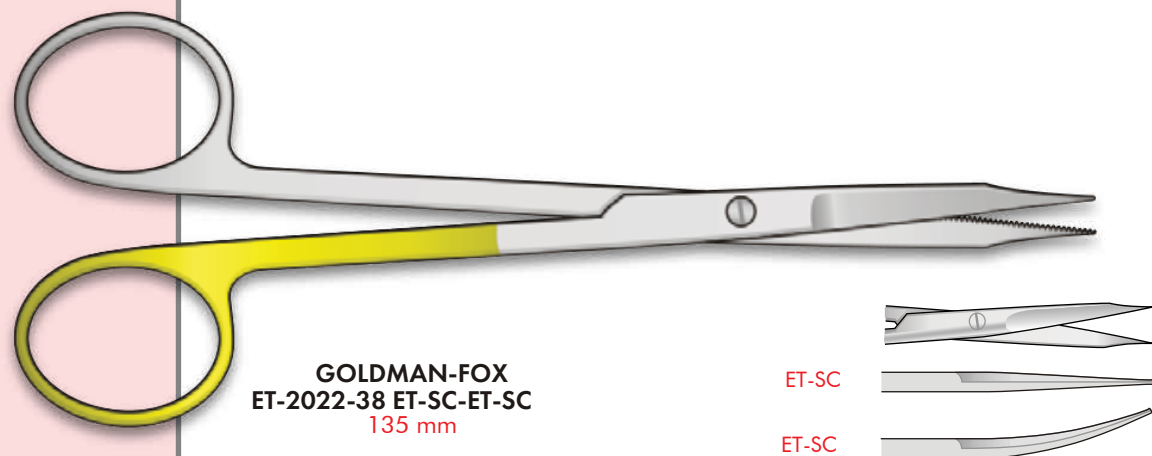
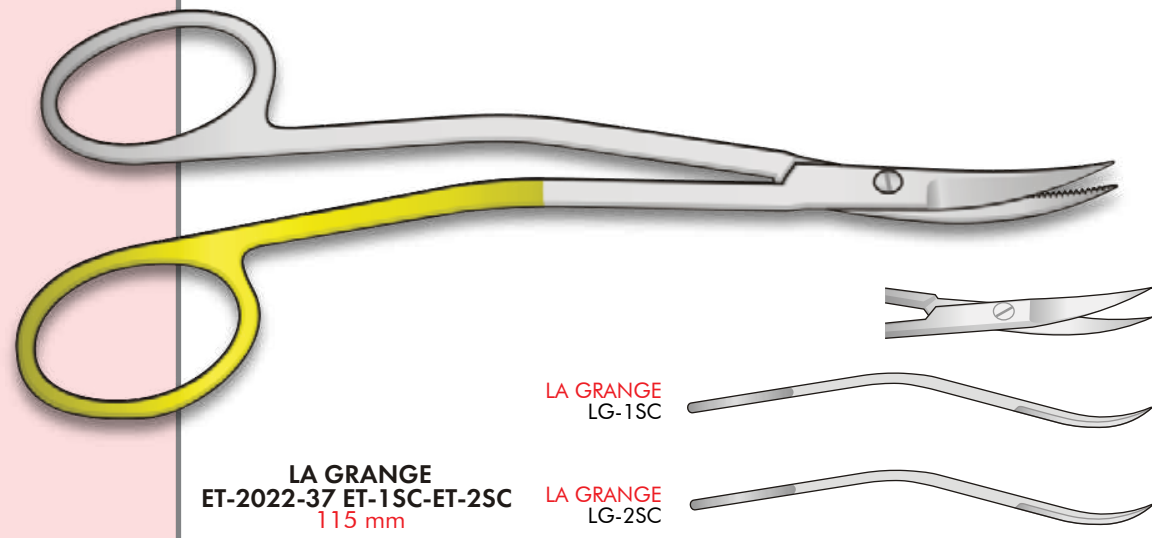

Super-cut™ scissors for gripping tissue and cutting interproximally

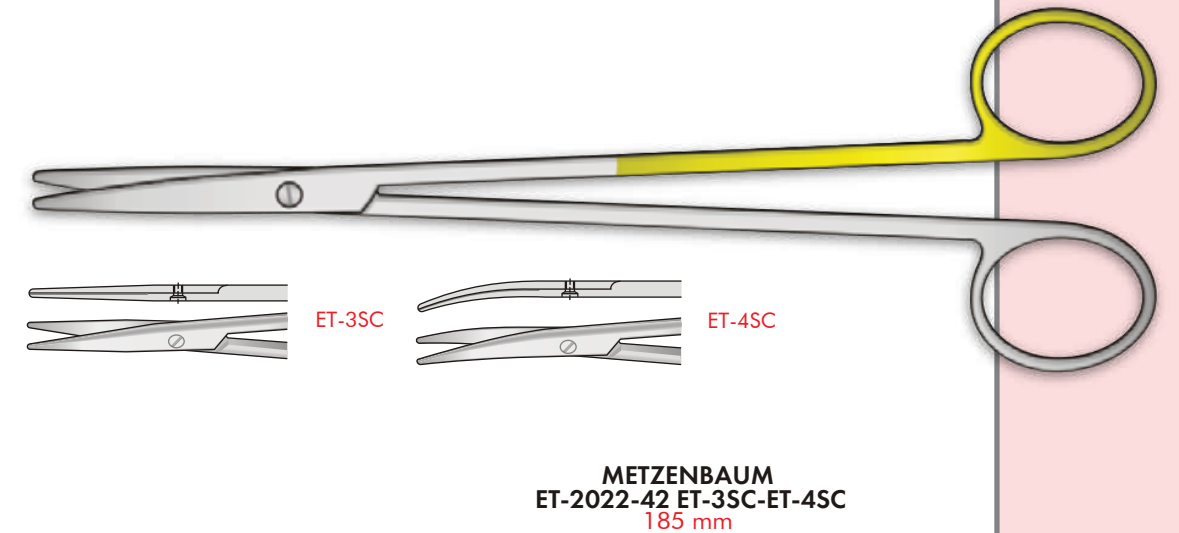
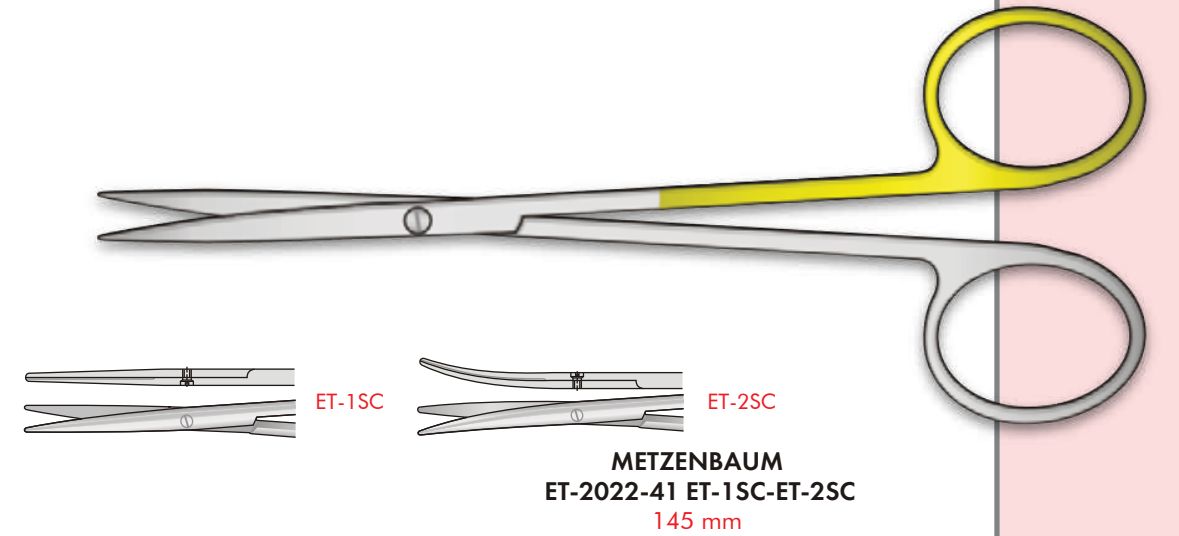
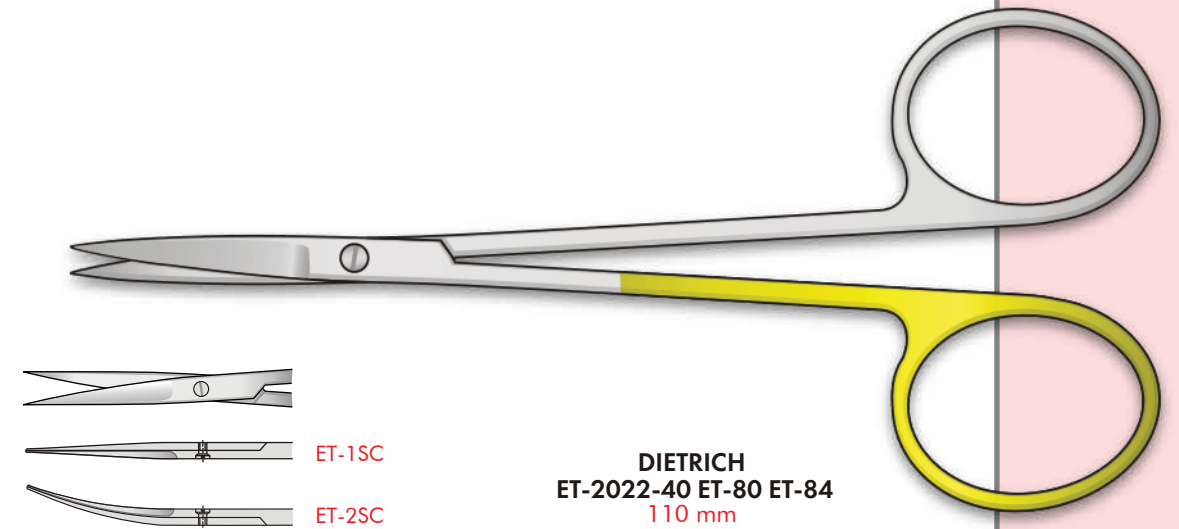

Super-cut™ scissors for gripping tissue and cutting interproximally

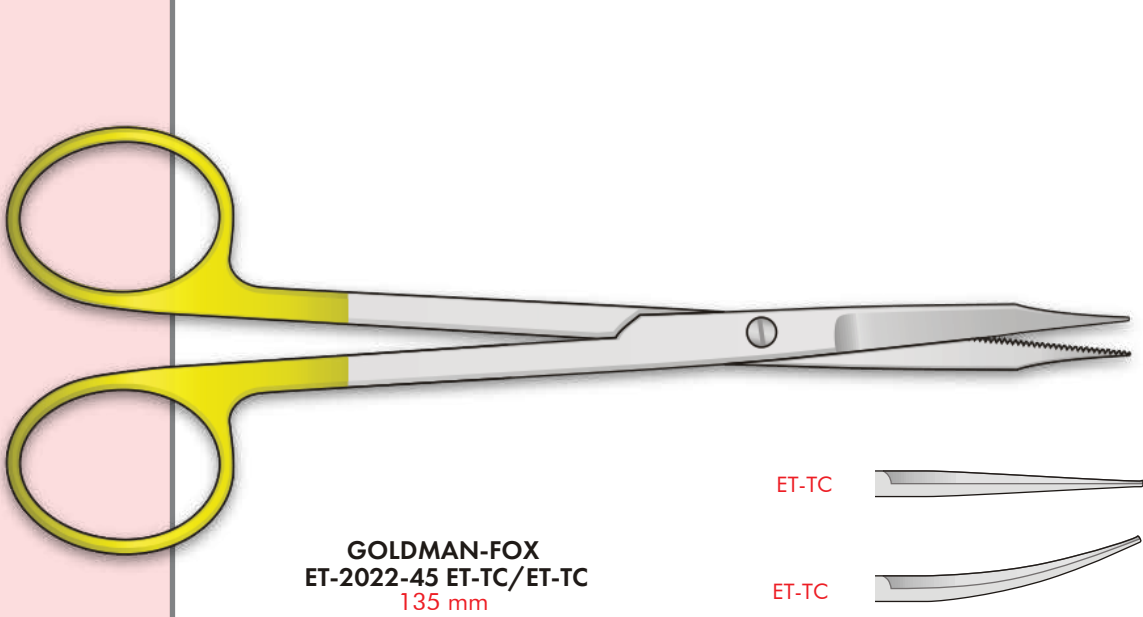
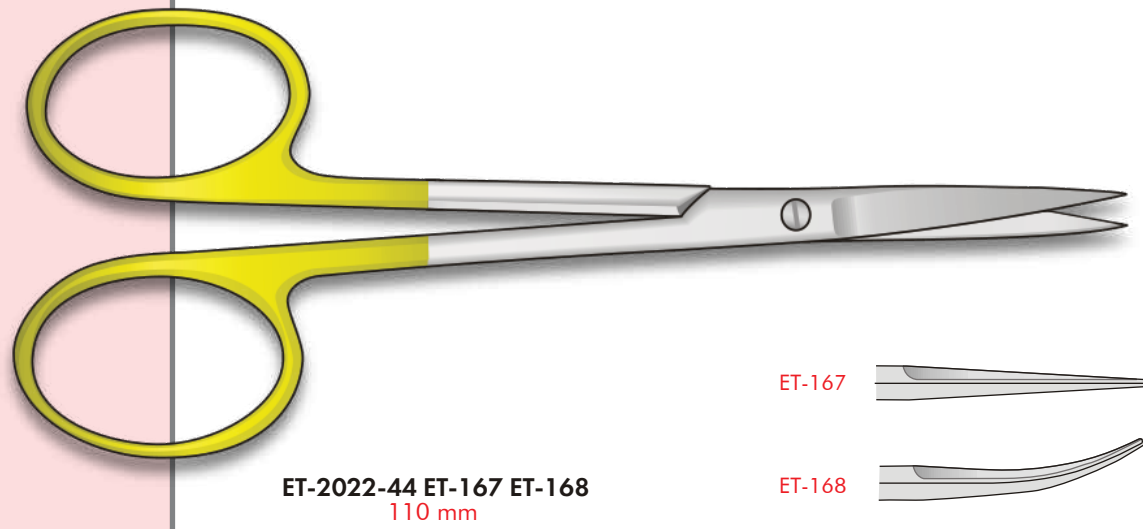
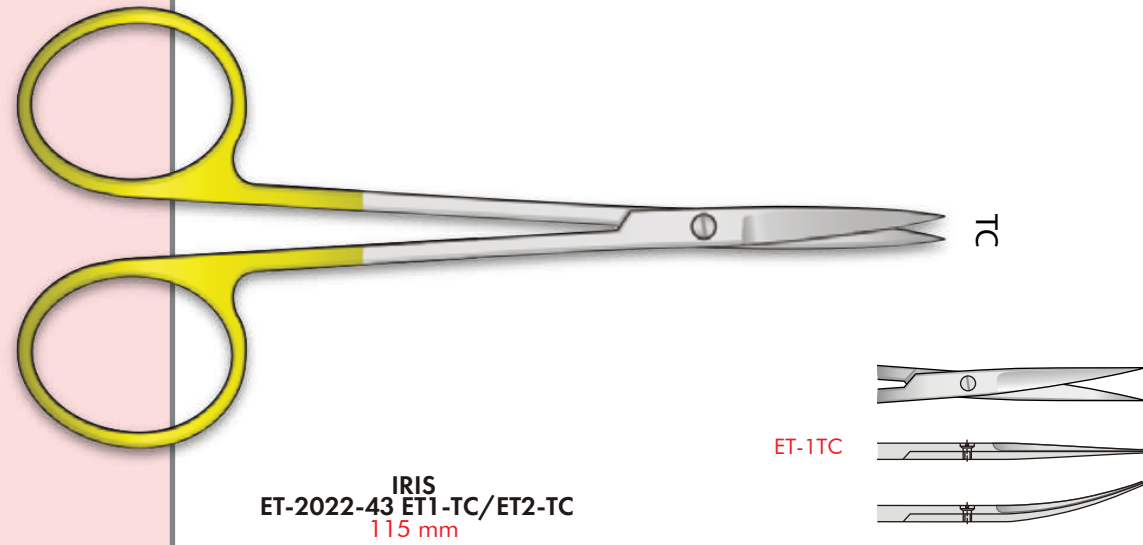

Super-cut™ scissors for gripping tissue and cutting interproximally

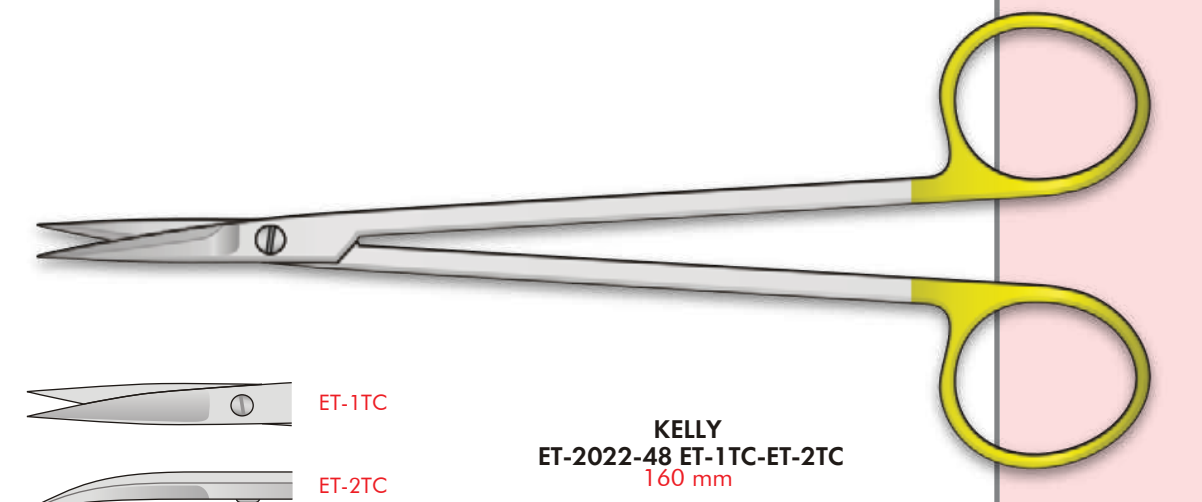
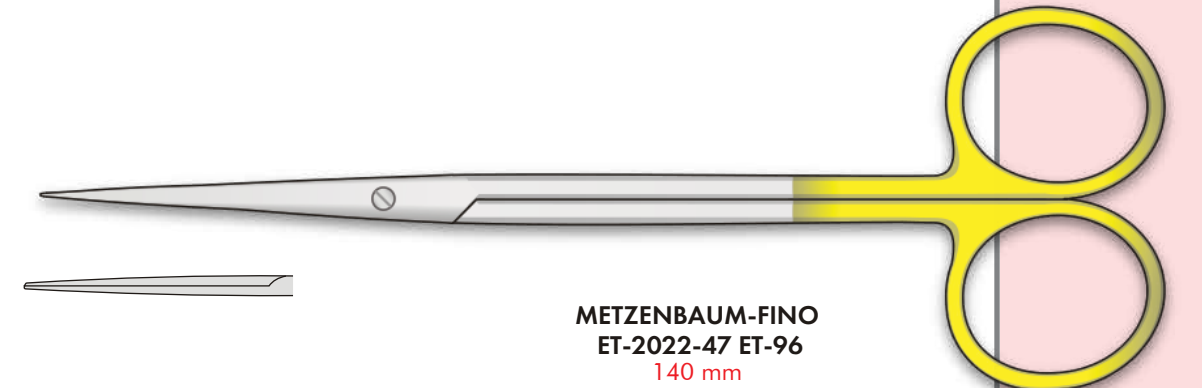
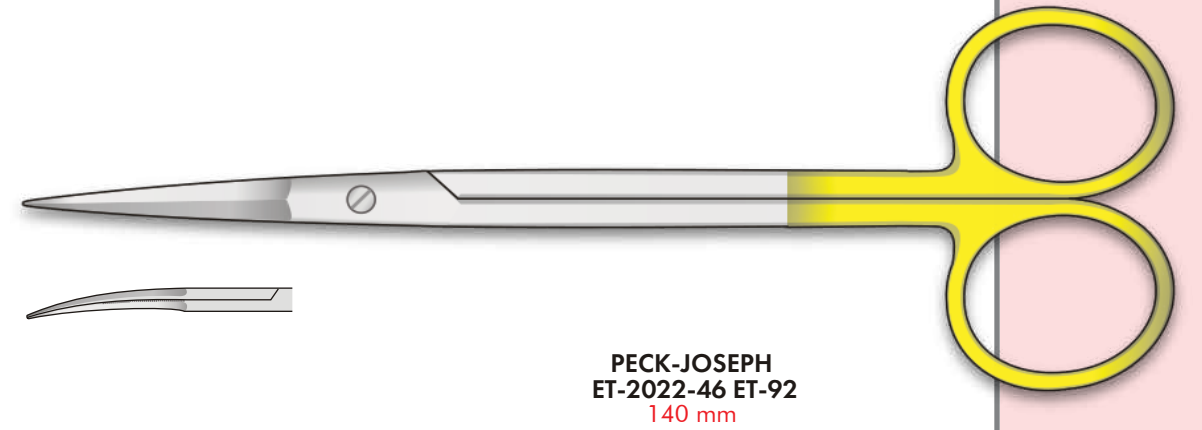

Vascular Scissors

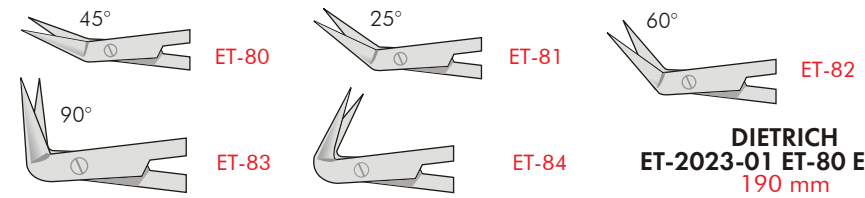
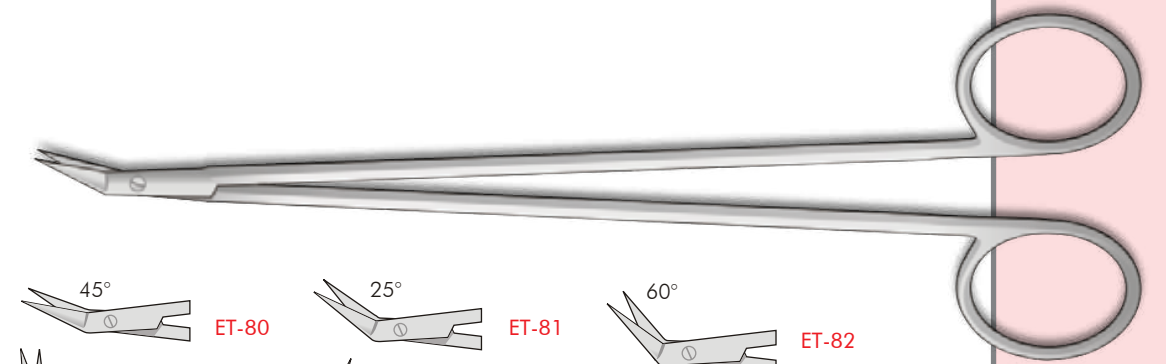
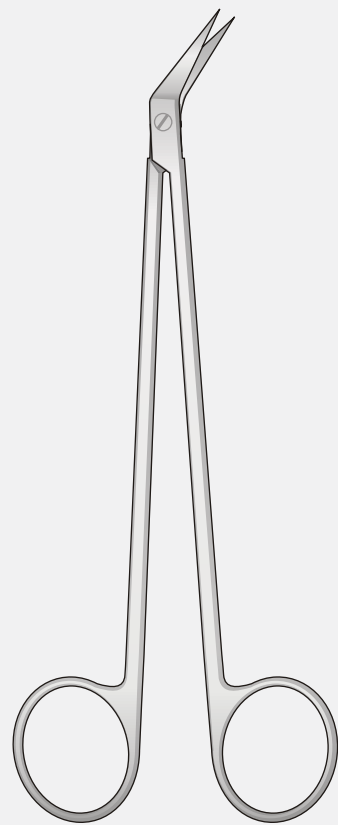

DIETRICH
ET-2023-01 ET-80 ET-84
190 mm

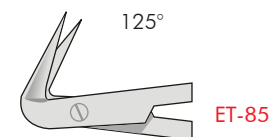
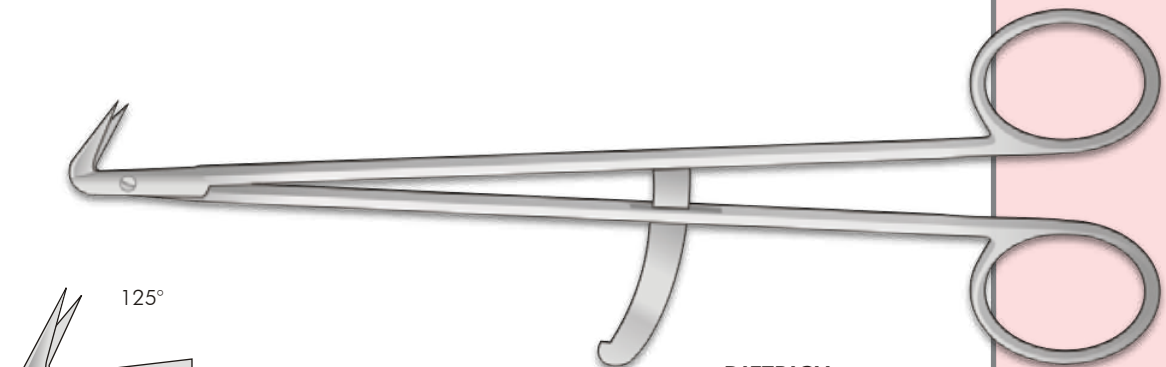

DIETRICH
ET-2023-02 ET-85
190 mm

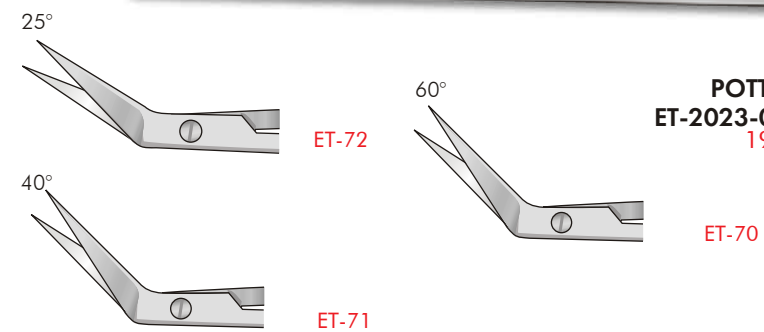
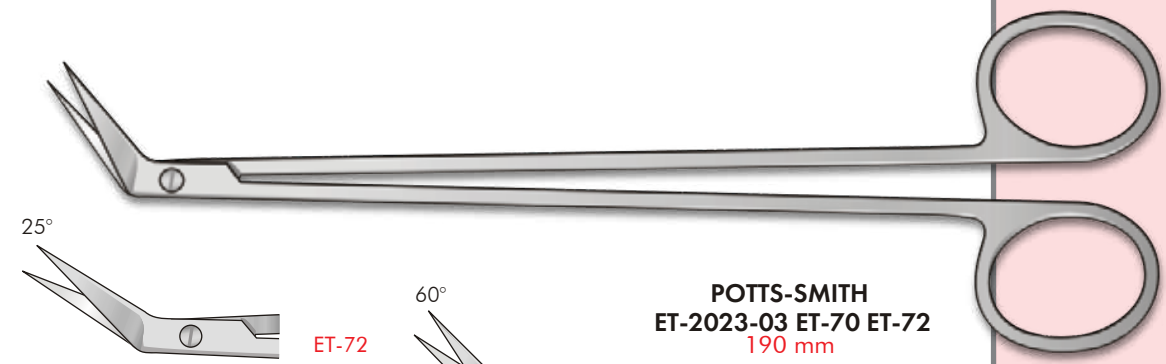

POTTS-SMITH
ET-2023-03 ET-70 ET-72
190 mm

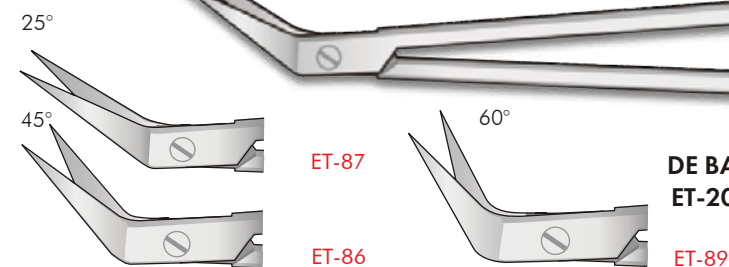
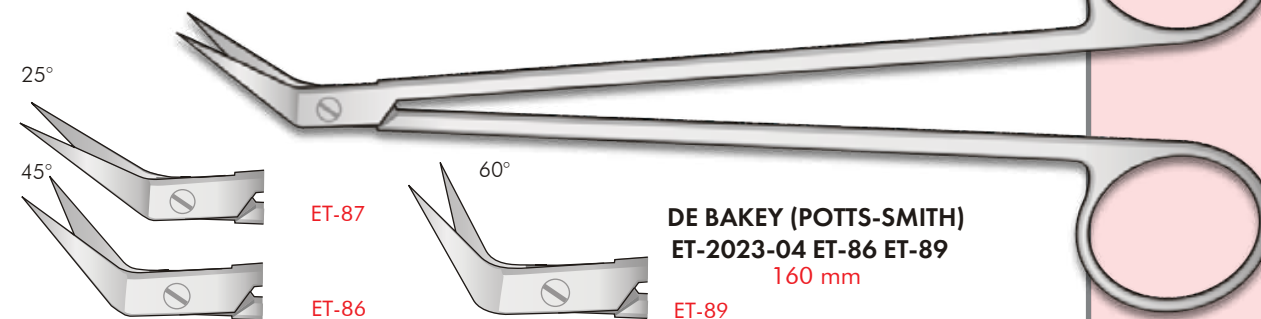

DE BAKEY (POTTS-SMITH)
ET-2023-04 ET-86 ET-89
160 mm

29

Tissue Forceps

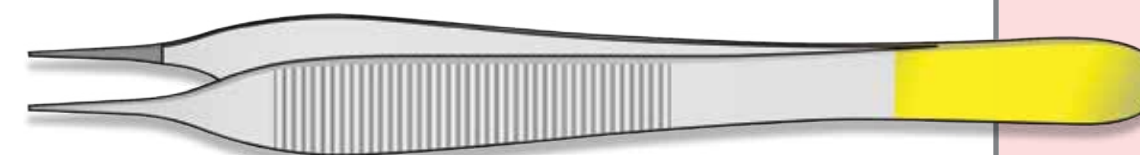
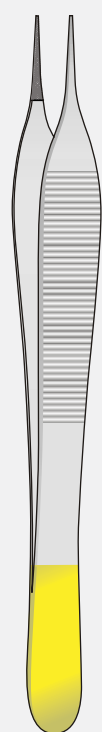

ET-230 120 mm ET-231 150 mm ADSON
ET-2024-01 ET-230-ET-231



ET-250 120 mm ET-251 150 mm ADSON
ET-2024-02 ET-250 ET-251



BD-210 130 mm BD-211 145mm
BD-212 160 mm BD-213 180 mm
BD-214 200 mm BD-215 250 mm
ADSON
ET-2024-03 ET-210 ET-215



ET-216 125mm ET-217 150mm SEMKIN
ET-2024-04 ET-216-ET-217



BD-233
200 mm



BD-232
150 mm

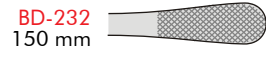

GERALD
ET-2024-05 ET-101
180 mm

BD-234
250 mm



BONNEY
ET-2024-06 BD-252
180 mm

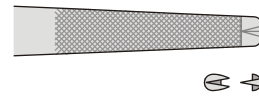

CUSHING
ET-2024-07 ET-226 ET-227
175 mm

ET-226
175 mm



ET-227
175 mm

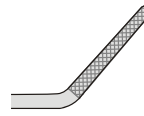

POTTS-SMITH
ET-2024-08 ET-218 ET-220

ET-218
180 mm



ET-219
200 mm



ET-220
250 mm



TAYLOR
ET-2024-09 ET-228
185 mm



GERALD
ET-2024-10 ET-101
180 mm

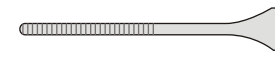

GERALD
ET-2024-11 ET-102
180 mm

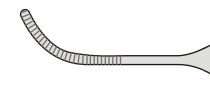

GERALD
ET-2024-12 MF-103
180 mm



GERALD
ET-2024-13 ET-104
180 mm



GERALD BROWN
ET-2024-14 ET-105
180 mm

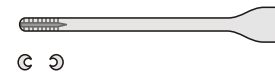

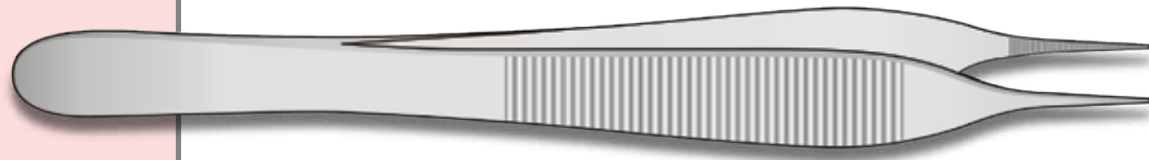

ET-31 120 mm ET-72 150 mm ET-71 120 mm
ADSON
 ET-2024-15 EET-31/ET-72

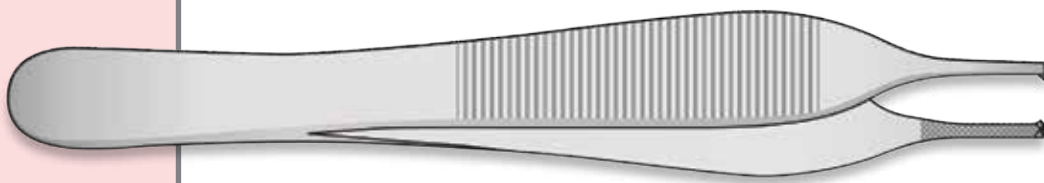

ADSON
 ET-2024-16 ET-90
 120 mm ET-90 120 mm

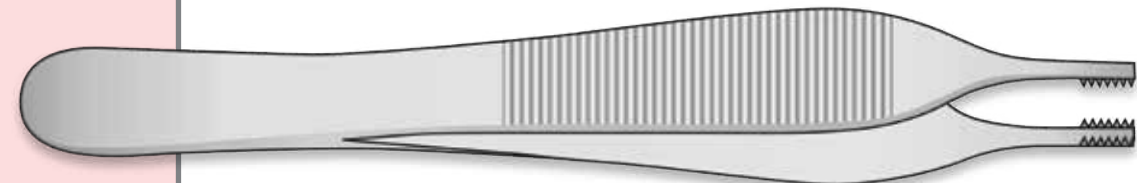

ET-141 141 mm 6x9 Teeth ET-93 120 mm 6x9 Teeth ET-92 120 mm 6x6 Teeth
ADSON-BROWN
 ET-2024-17 ET-92/ET-141
 120 mm



POTTS-SMITH
 ET-2024-18 ET-14/ET-54
 BD-53 180 mm BD-14 180 mm
 BD-54 210 mm BD-15 210 mm



ET-289 250 mm ET-288 210 mm ET-287 180 mm
POTTS-SMITH
 ET-2024-19 ET-287/ET-289



ET-95 ET-91
SEMKEN
 ET-2024-20 ET-91 ET-95
 150 mm



ET-180 ET-181
CUSHING
 ET-2024-21 ET-180/ET-181
 175 mm



ET-106 115 mm ET-138 145 mm
 ET-107 160 mm ET-139 180 mm
 ET-108 200 mm
ET-2024-22
 ET-106 ET-139



ET-118 145 mm ET-149 160 mm
ET-2024-23
 BD-118-BD-149



ET-96 ET-07 ET-04

GRAEFE
ET-2024-24 BD-04/BD-07
100 mm



ET-196 ET-195 ET-194

GRAEFE
ET-2024-25 ET-194/ET-196
100 mm

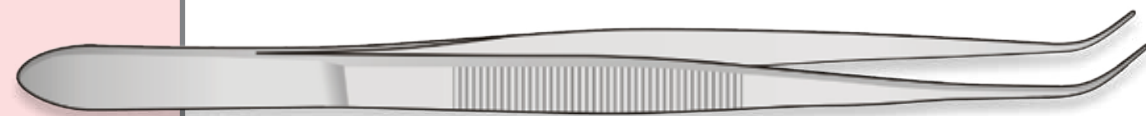

PERRY
ET-2024-26 ET-05
125 mm



PERRY
ET-2024-27 et-06
125 mm

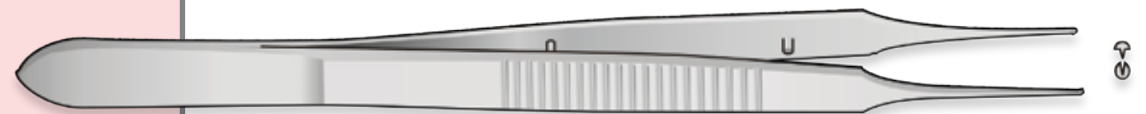

ET-2024-28
ET-238-ET-239

ET-238
95 mm
1x2 denti
0,2 mm

AUSTIN
ET-239
140 mm
0,8 mm



ET-44
130 mm

SEMKEN
ET-2024-29 ET-44
130 mm



SEMKEN
ET-2024-30 ET-45
130 mm



SEMKEN
ET-2024-31 ET-46
130 mm

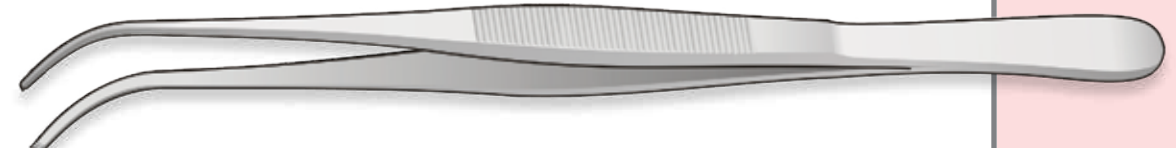

SEMKEN
ET-2024-32 ET-47
130 mm



ADSON
ET-2024-33 ET-30 - ET-73

37

Delicate Forceps

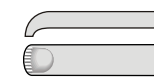

ET-151
140 mm

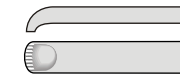

ET-252
160 mm

DURANTE
ET-2025-01 ET-151 ET-152

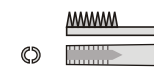

8 x 8 Teeth

BROWN
ET-2025-02 ET-94
150 mm



SELMAN
ET-2025-02 ET-157
150 mm



SINGLEY-TUTTLE
ET-2025-03 ET-29
230 mm



SINGLEY-TUTTLE
ET-2025-03 BD-29
230 mm



ET-2025-03 ET-60 ET-62
110 mm



ET-2025-04 ET-64-ET-66
110 mm

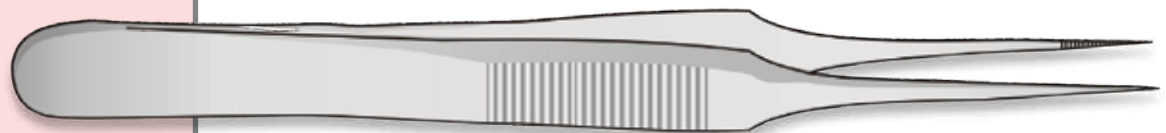

ET-2025-05 ET-68
90 mm



ET-2025-06 ET-200-203
90 mm

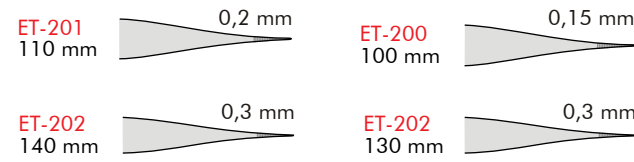

ET-2027-07 ET-205
115 mm

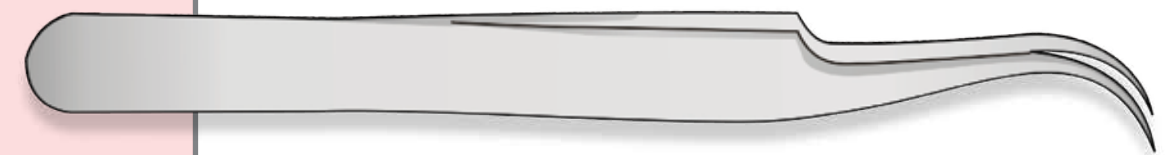

ET-2025-08 ET-206
115 mm



GRAEFE
ET-2025-09 ET-135
110mm



GRAEFE
ET-2025-10 ET-136
110 mm

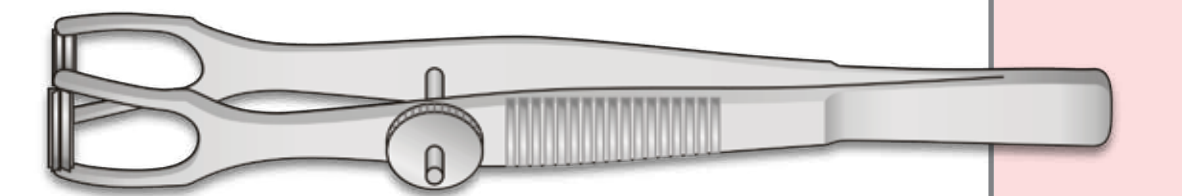

COTTLE
ET-2025-11 ET-140
100 mm

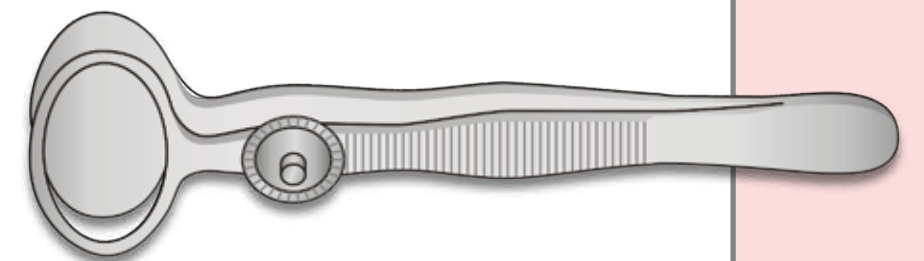
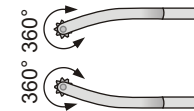

DESMARRES
ET-2025-12 ET-130 ET-132
90 mm

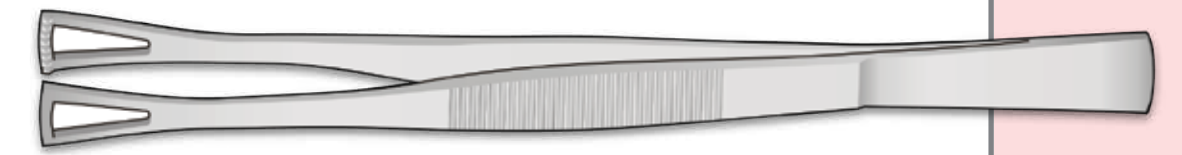
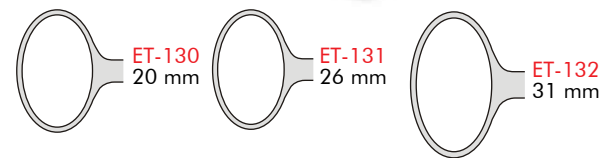

DUVAL
ET-2025-13 ET-198 ET-199

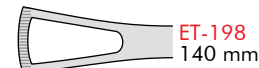



ET-127 -150 mm	Ø 2 mm	ET-124 -150 mm	Ø 1 mm
ET-128 -180 mm		ET-125 -180 mm	
ET-129 -210 mm		ET-126 -210 mm	
ET-149 -230 mm		ET-148 -230 mm	

ET-2025-14 ET-124/ET-149
120 mm



ET-2025-15
ENT-142T/ENT-343T

ET-142T 150 mm	1 x 0,5mm	ET-143T 180 mm	1 x 0,5mm
----------------	-----------	----------------	-----------

MICRO-RING
TWEEZERS Ø 8MM



ET-2025-16
EN-354T/EN-359T

Atrauma-Standard 1,8 mm	ET-354T 150 mm	Atrauma-Standard 1,8 mm	ET-355T 150 mm
Atrauma-Standard 1,8 mm	ET-356T 180 mm	Atrauma-Standard 1,8 mm	ET-357T 180 mm
Atrauma-Standard 1,8 mm	ET-358T 210 mm	Atrauma-Standard 1,8 mm	ET-359T 210 mm

MICRO-ATRAUMA
TWEEZERS Ø 8 MM



MICRO-TWEEZERS
Ø 8 MM

6 x 0,4 mm	ET-362T 150mm	6 x 0,4 mm	ET-363T 150mm
6 x 0,8 mm	ET-364T 180mm	6 x 0,8 mm	ET-365T 180mm

ET-2025-17
EN-362/EN-365

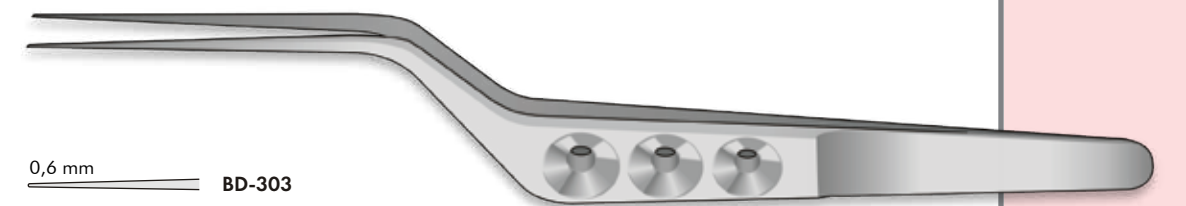

0,6 mm BD-303

YASARGIL
ET-2025-17 ET-303
180 mm



Ø 3 mm	ET-314	Ø 5 mm	ET-315
--------	--------	--------	--------

YASARGIL
ET-2025-18 ET-314-315
180 mm



ET-2025-19 ENT-110 / ENT-111
120 mm

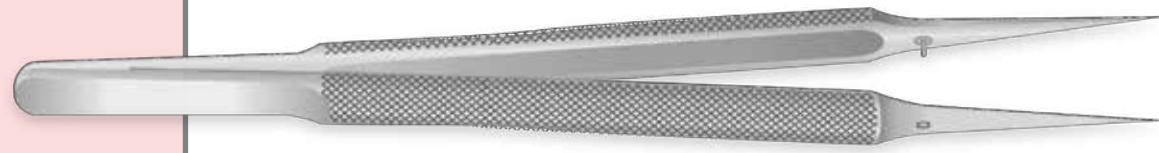

ET-2025-20 ENT-112 / ENT-113
130 mm

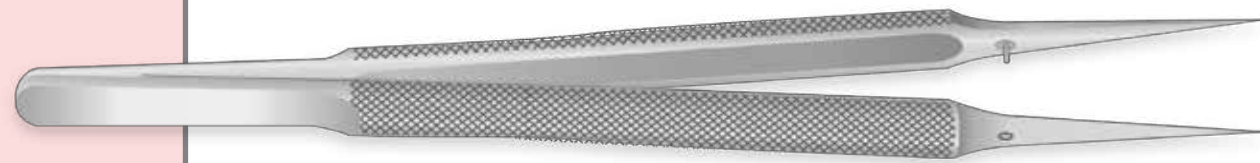

ET-2025-21 ENT-114 / ENT-115
150 mm

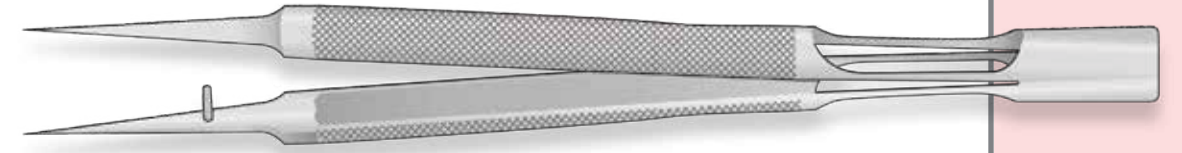

BROCK
ET-2025-22
130 mm

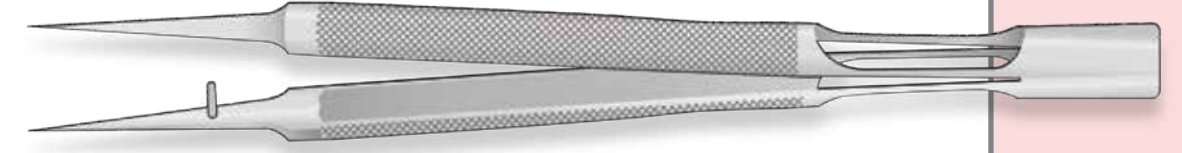

BROCK
ET-2025-23
135 mm

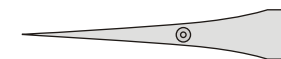
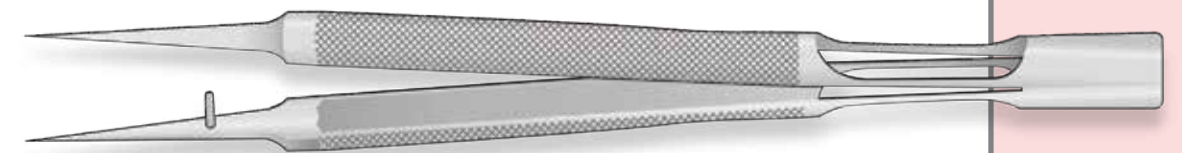

BROCK
ET-2025-24
130 mm



BROCK
ET-2025-25
130 mm

45

Thumb and Tissue Forceps



ET-2026-01
ET-32 ET-33
100 mm



ET-2026-02
ET-34
100 mm

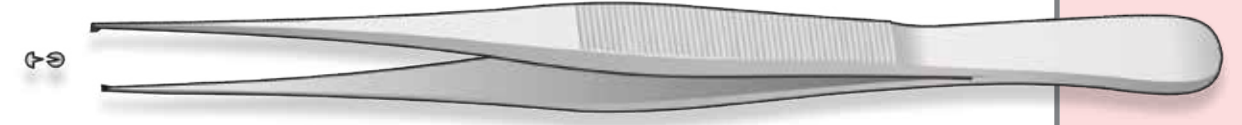

ET-2026-03
ET-35 ET-36
100 mm

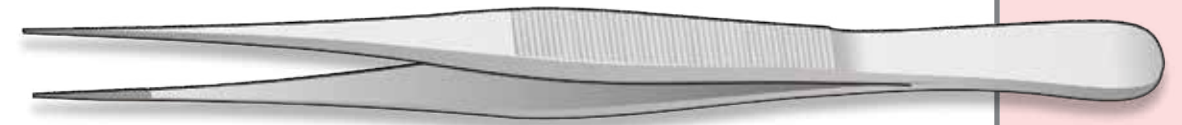

ET-2026-04
BD-40
110 mm



ET-2026-04
ET-41
110 mm

Ear Forceps

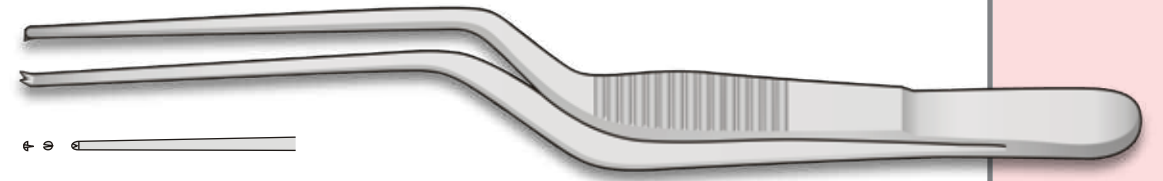
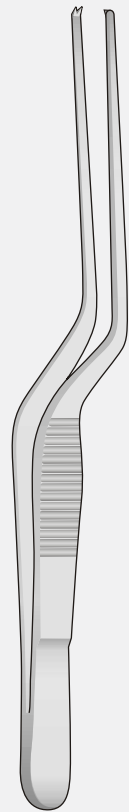

LUCAE
ET-2027-01 ET-147
140 mm



LUCAE
ET-2027-02 ET-101
140 mm



JANSEN
ET-2027-03 ET-102
160 mm

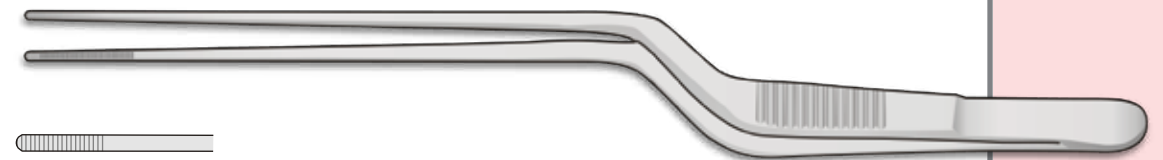



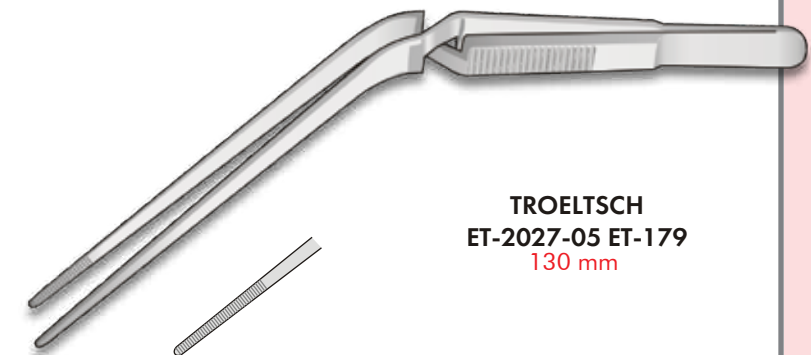



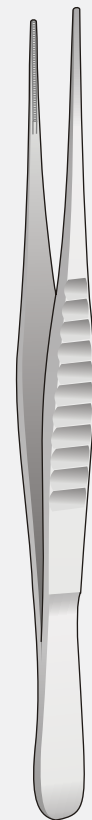

GRÜNWARD
ET-2027-04 ET-193
200 mm

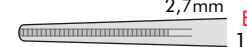
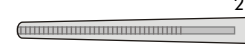

TROELTSCH
ET-2027-05 ET-179
130 mm

Atraumatic Tissue Forceps





- | | |
|---|---|
|  2,7mm
ET-167
200 mm |  2,7mm
ET-166
160 mm |
|  2,7mm
ET-169
300 mm |  2,7mm
ET-168
240 mm |
|  3,5mm
ET-171
200 mm |  3,5mm
ET-170
160 mm |
|  3,5mm
ET-173
300 mm |  3,5mm
ET-172
240 mm |







DURANTE
ET-2028-01 ET-151ET-152

Non-Traumatic Vascular Tissue Forceps

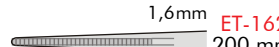

- | | |
|---|---|
|  2,8mm
ET-190
200 mm |  2,8mm
BD-191
250 mm |
|  2,8mm
ET-192
300 mm | DE BAKEY
ET-2028-02 ET-190 ET-192
195 mm |

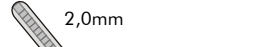
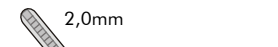
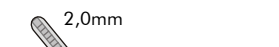

- | | | |
|---|---|---|
|  1,6mm
ET-160
160 mm |  1,6mm
ET-161
180 mm |  1,6mm
ET-162
200 mm |
|  2,0mm
ET-80
160 mm |  2,0mm
ET-81
180 mm |  2,0mm
ET-83
200 mm |
|  2,0mm
ET-85
200 mm |  2,0mm
ET-84
180 mm |  2,0mm
ET-82
160 mm |

DE BAKEY
ET-2028-03 ET-80/ET-164

Cilia Forceps

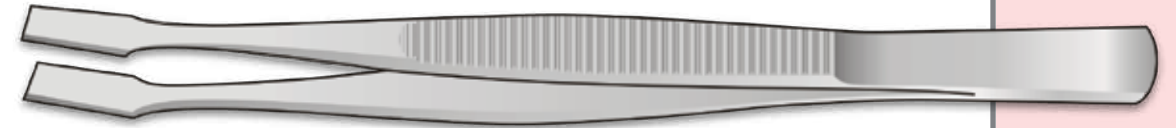
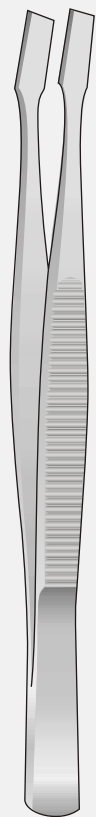

KÜHNE
ET-2029-01 ET-44
105 mm

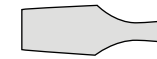

LITTAUER
ET-2029-02 ET-64
85 mm



BARRAQUER
ET-2029-03 ET-65
105 mm



ET-2029-04 ET-45
90 mm



ET-2029-05 ET-45
90 mm

53

Scalpel Blades & Handles



ET-18
35 mm

ET-20
35 mm

GRAEFE
ET-2030-01 ET-18 ET-20
140 mm



ET-14
125 mm

ET-16
135 mm

GRAEFE
ET-2030-02X ET-14 ET-16

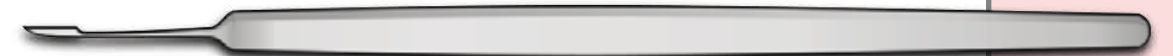

ET-06
5 mm

ET-08
6 mm

ET-10
7 mm

ZIEGLER
ET-2030-03 ET-06 ET-10
115 mm

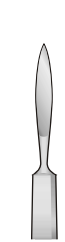
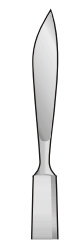

ET-2030-03
ET-30 ET-40

ET-30 120 mm ET-32 125 mm ET-34 130 mm ET-36 120 mm ET-38 125 mm ET-40 130 mm



DESMARRES
ET-2030-04 ET-95
135 mm



DESMARRES
ET-2030-05 ET-96
135 mm



ET-2030-06 ET-90
180 mm



ET-2030-07 ET-91
280 mm



JOSEPH
ET-2030-08 NK-100
150 mm

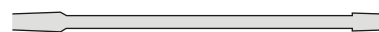

ET-2030-09 ET-B3
Fig. 3



ET-2030-10 ET-B3M
Fig. 3M



ET-2030-11 ET-B7
Fig. 7



ET-2030-12 ET-B1
Fig. 5



ET-2030-13 ET-B2
Fig. 5a

2,5 mm

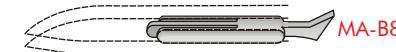

MA-B8

2,5 mm

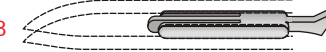

MA-B9

ET-2030-14 ET-B8 ET-B9
155 mm

61

Forceps

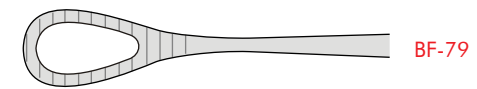
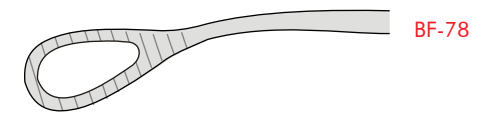
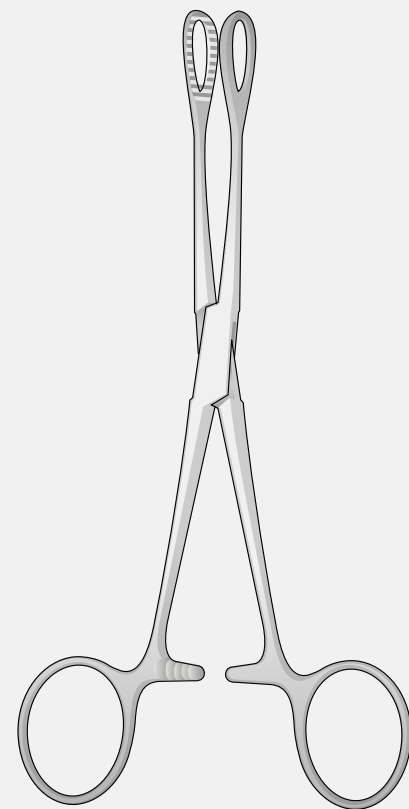

FOERSTER BALLENGER
BF-78/BF-79
180 mm

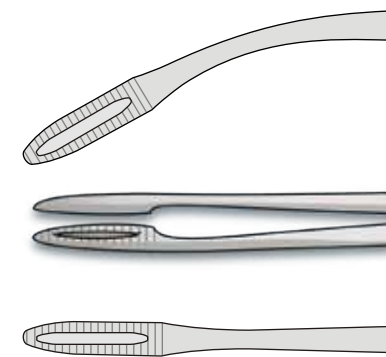

GROSS
BF-94/BF-95
200 mm

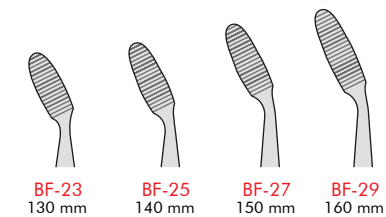

PEAN-MURPHY
BF-23-BF-29

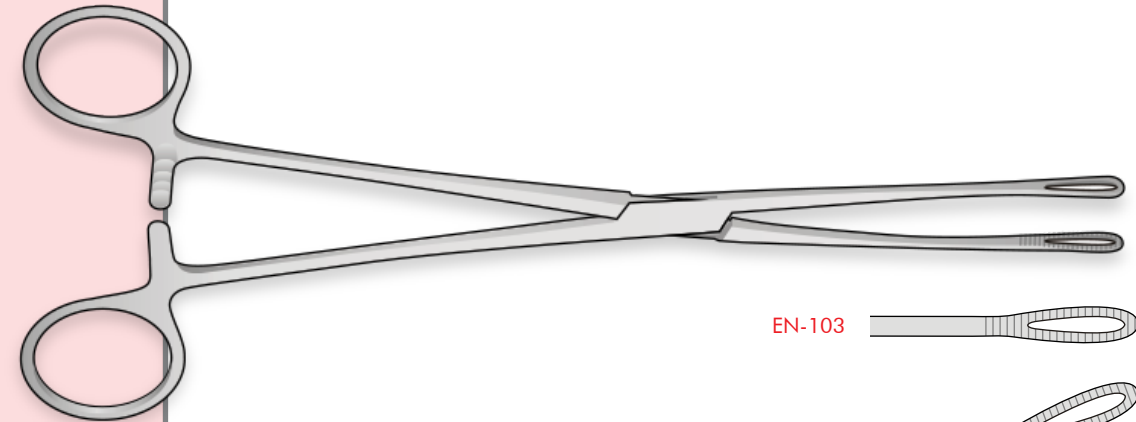

FOERSTER
BF-103-BF-104
250 mm

EN-103

EN-104



HEYWOOD-SMITH
EN-98
250 mm

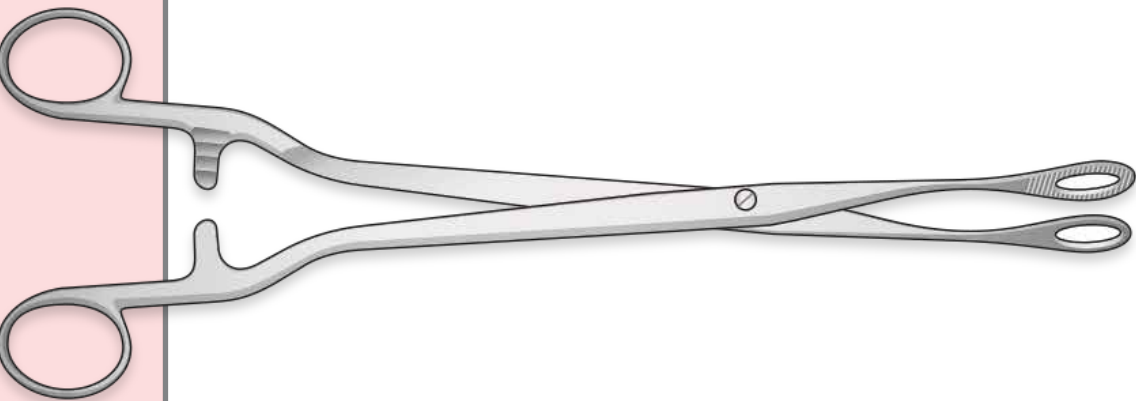
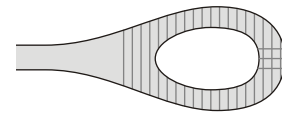

NOTO
NOTO
280 mm

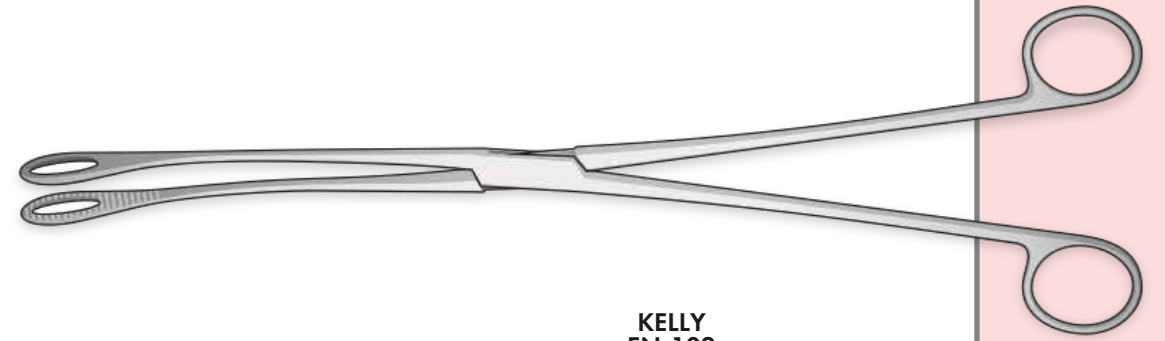

KELLY
EN-102
320 mm

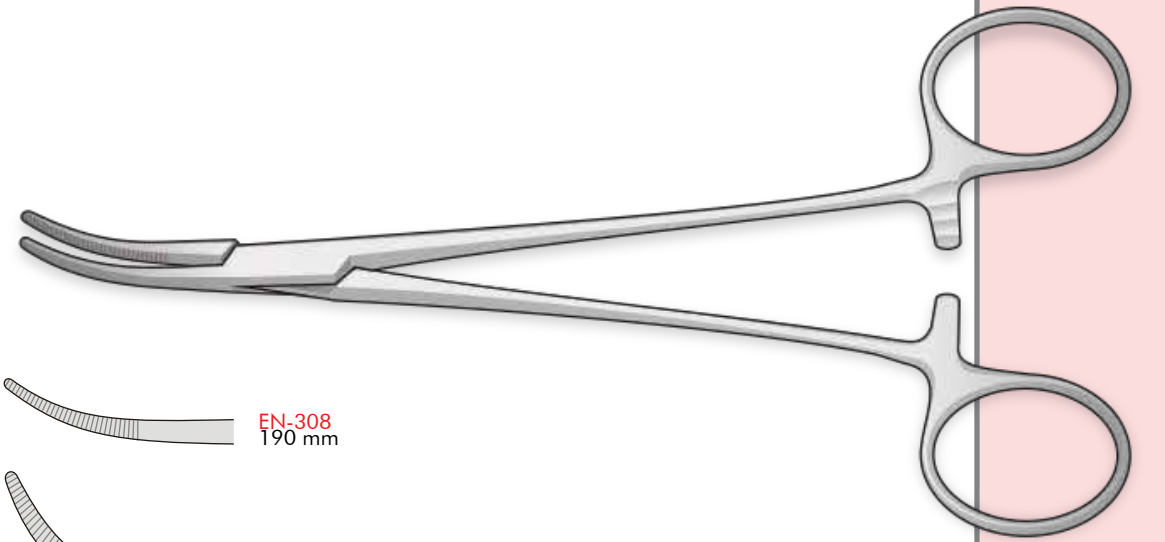

EN-308
190 mm

EN-309
190 mm

SCHNIDT
EN-308 EN-309
190 mm

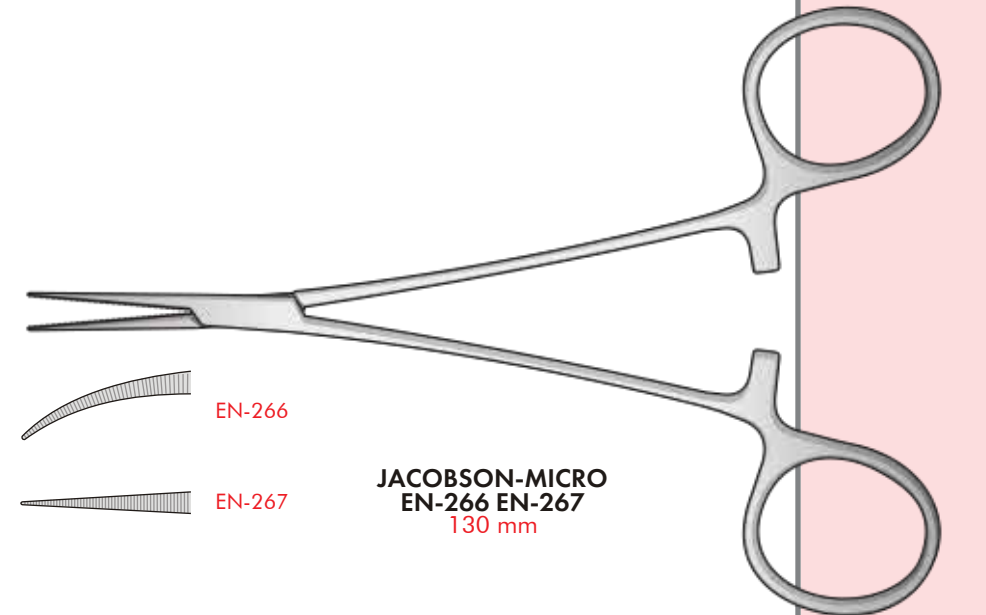

EN-266

EN-267

JACOBSON-MICRO
EN-266 EN-267
130 mm

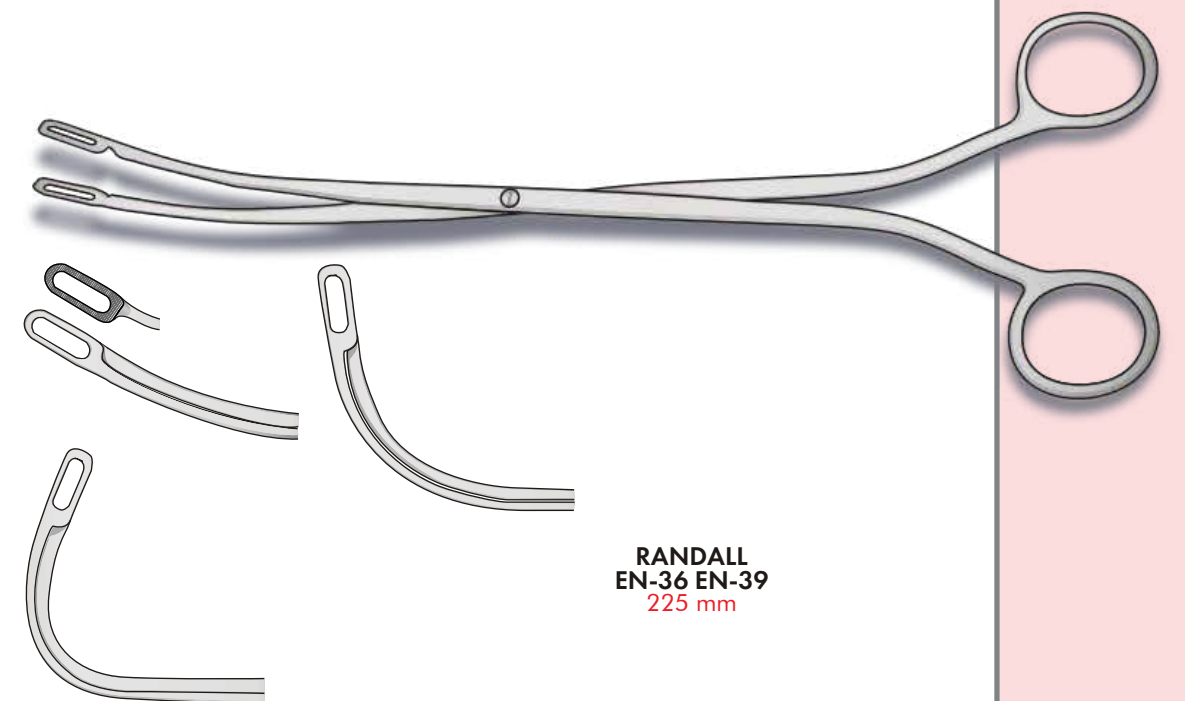
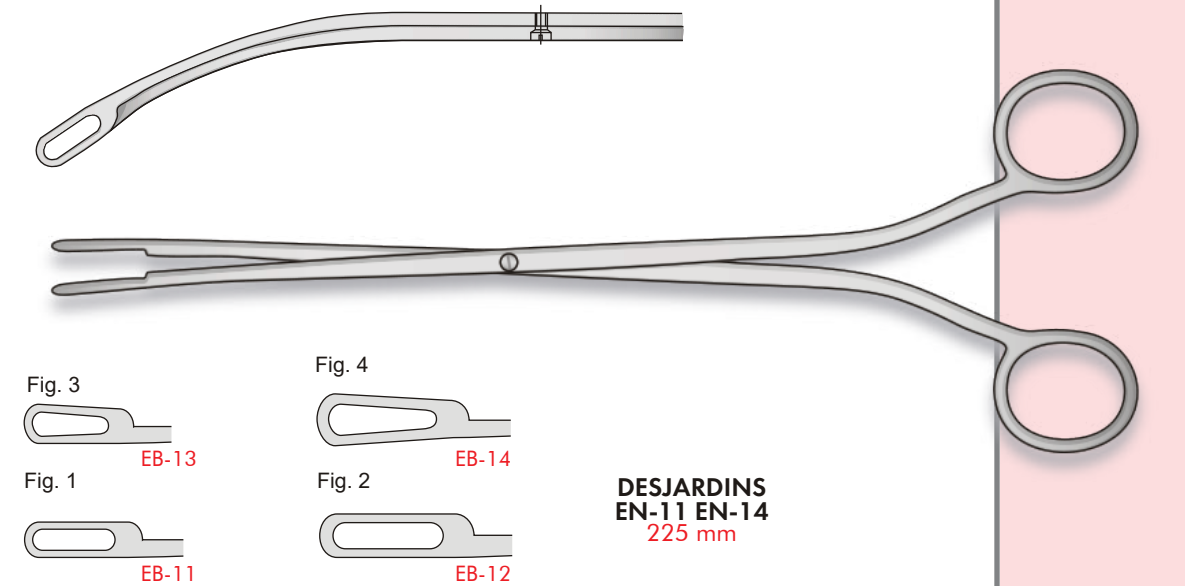
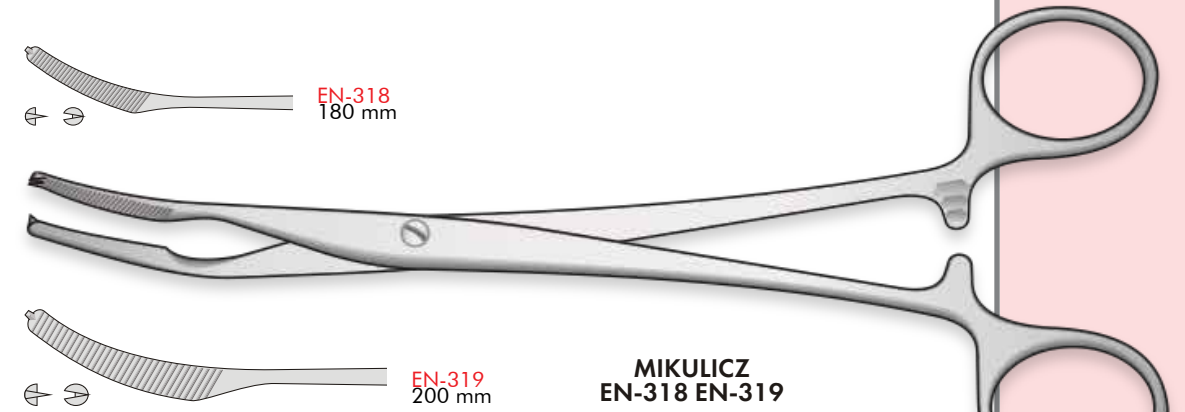
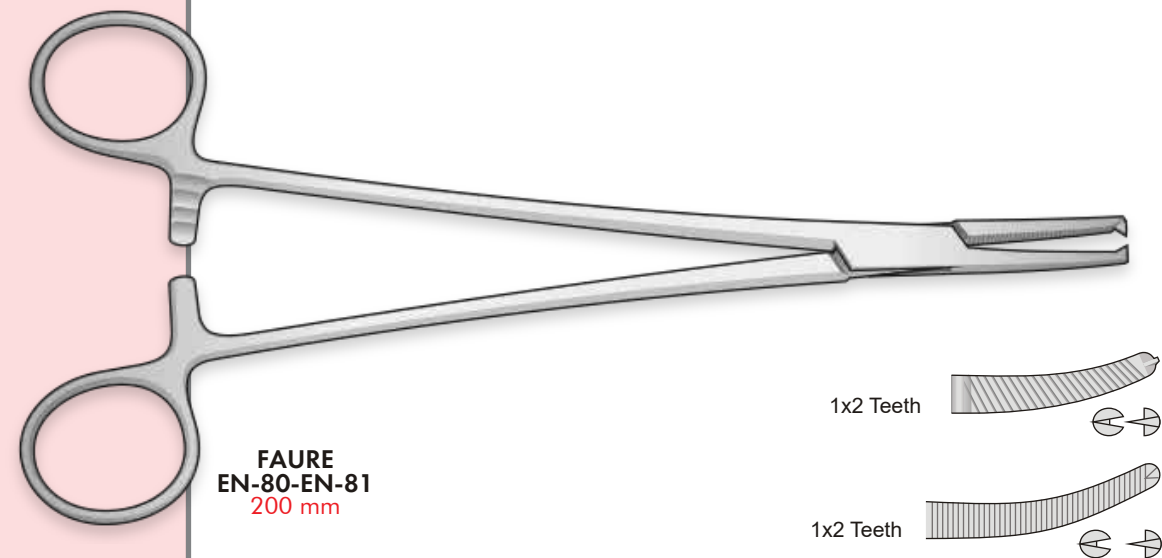
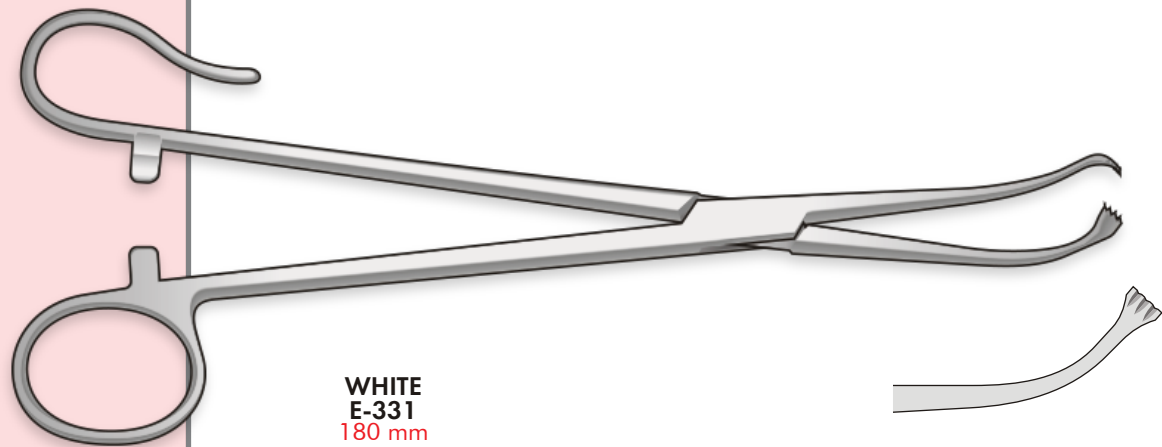
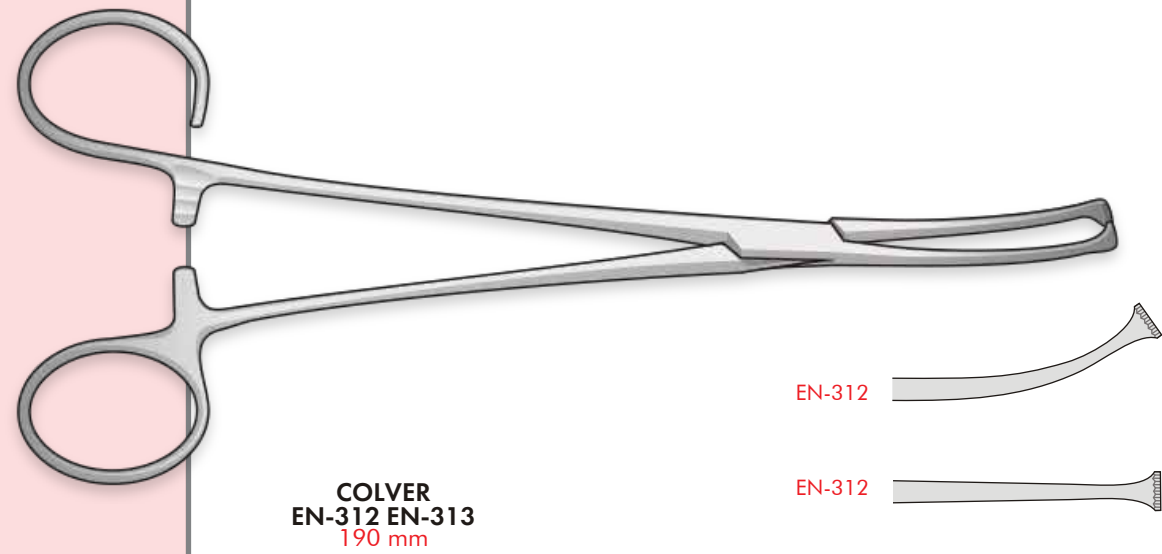



EN-32 EN-33
280 mm

BF-33

BF-32

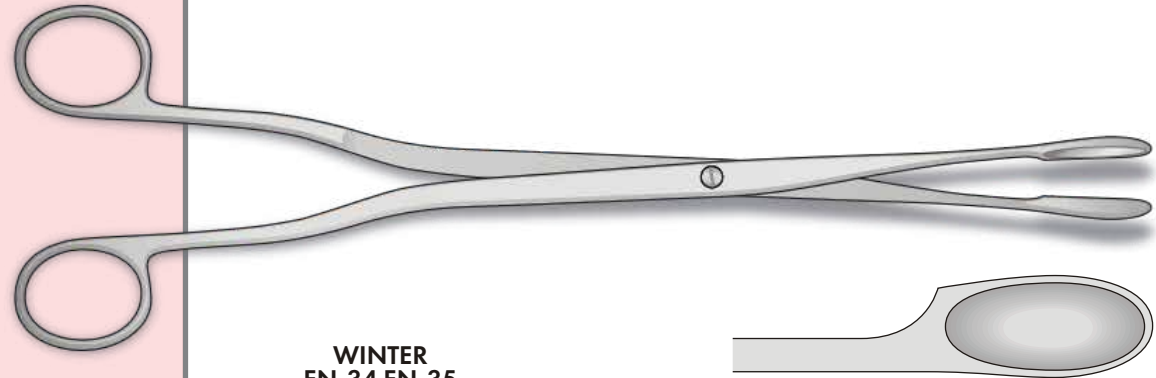

WINTER
EN-34 EN-35
280 mm

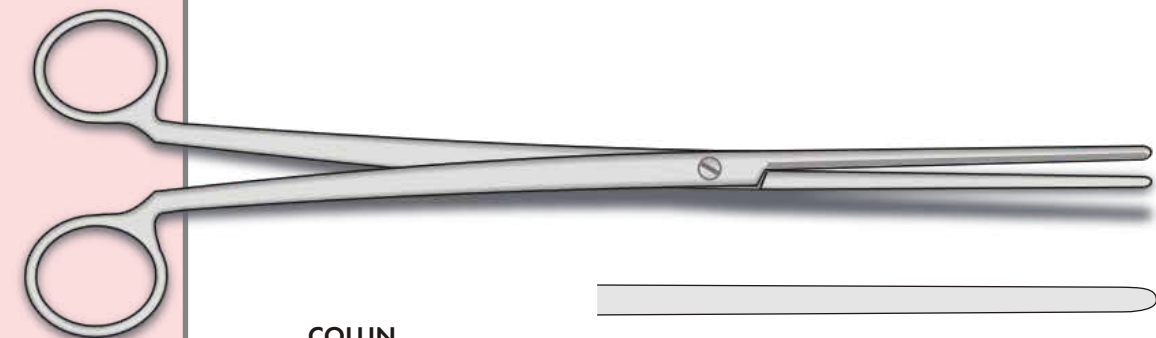

EN-03
COLLIN
260 mm

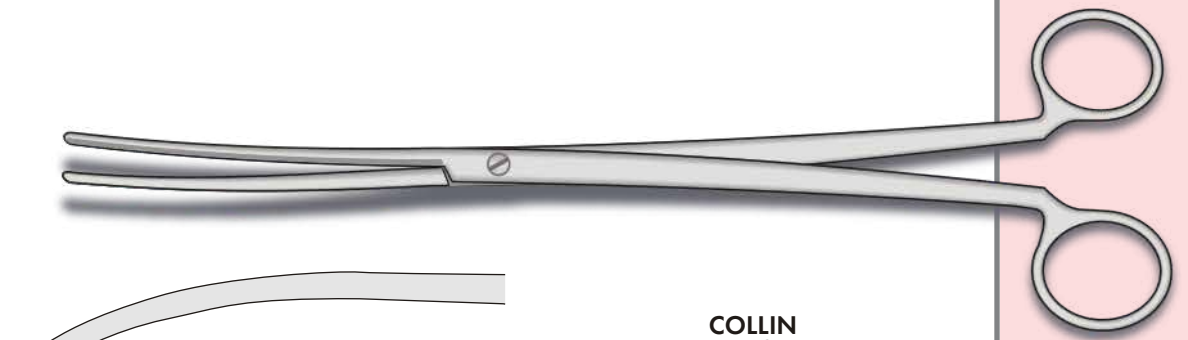

COLLIN
EN-04
260 mm



MAIER
EN-01 EN-02
245 mm

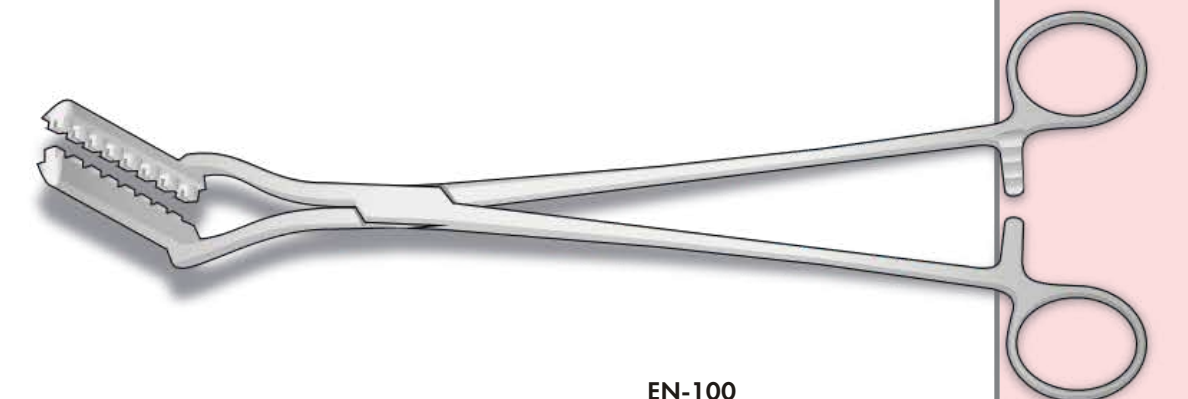

EN-100
280 mm

CONTACT INFO

ADDRESS

Endo Tech Instruments Manufactures
Company Al Muslim Street Islam Nagar
Sialkot - 51310 Pakistan

E-MAIL

info@endotech.com.pk
endotechinstruments@gmail.com

WEB

www.endotech.com.pk
www.myendotech.com

MOBILE

+92 333 87 20 804

PHONE

+92 52 4352088

