



Care with Trust ...

**ENDO TECH**  
Instruments

# **ENT INSTRUMENT**

Quality and trust are two major factors that an ETI instruments takes into consideration while selecting Wrangler Instruments



## **ENDO TECH INSTRUMENTS**

P.O.Box 963 Al Muslims Street No.5,  
Islam nagar Road, Pacca Garha, Sialkot-51310-Pakistan  
Cell:+92 3338720804, Phone: +92-52-4352088  
Email: info@endotech.com.pk Web: www.endotech.com.pk

[www.endotech.com.pk](http://www.endotech.com.pk)



Care with Trust ...

**ENDO TECH**  
Instruments

### Ear specula

for children



- ① = Ø 2,0 mm  
ETI-200-101
- ② = Ø 3,5 mm  
ETI-200-102
- ③ = Ø 5,0 mm  
ETI-200-103

**Hartmann**

Pieces Fig.

Set of 3 1-3 ETI-200-111

for adults



- ② = Ø 3,5 mm  
ETI-200-104
- ③ = Ø 5,0 mm  
ETI-200-105
- ④ = Ø 6,5 mm  
ETI-200-106
- ⑤ = Ø 7,5 mm  
ETI-200-107

**Hartmann**

Pieces Fig.

Set of 3 3-5 ETI-200-112  
4 2-5 ETI-200-113

for adults



- ① = Ø 3,0 mm  
ETI-200-108
- ② = Ø 4,0 mm  
ETI-200-109
- ③ = Ø 5,0 mm  
ETI-200-110

**Politzer**

Pieces Fig.

Set of 3 1-3 ETI-200-1133

for adults



- ① = Ø 3,0 mm  
ETI-200-115
- ② = Ø 4,0 mm  
ETI-200-116
- ③ = Ø 5,0 mm  
ETI-200-117
- ④ = Ø 6,5 mm  
ETI-200-118

**Toynbee**

Pieces Fig.

Set of 3 2-4 ETI-200-119  
4 1-4 ETI-200-120



Care with Trust ...

**ENDO TECH**  
Instruments



ETI-200-121



**HARTMAN ALLIGATOR FORCEPS**  
Serrated, 1 x 2 teeth, 3-3/8" (9 cm)

ETI-200-122



ETI-200-123



**HOEN ALLIGATOR FORCEPS**  
Serrated, 1 x 2 teeth, 5-7/8" (15 cm)

ETI-200-124

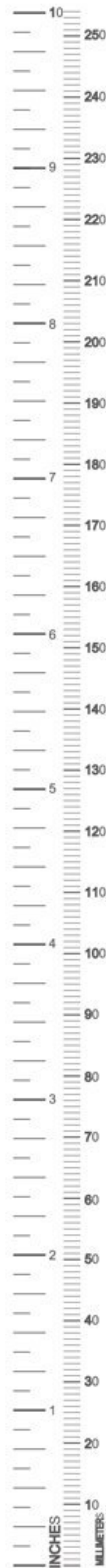



Care with Trust ...

**ENDO TECH**  
I n s t r u m e n t s



ETI-200-125



**HARTMAN ALLIGATOR FORCEPS**  
Serrated, 2 mm tip, 5-1/2" (14 cm)

ETI-200-126



ETI-200-127

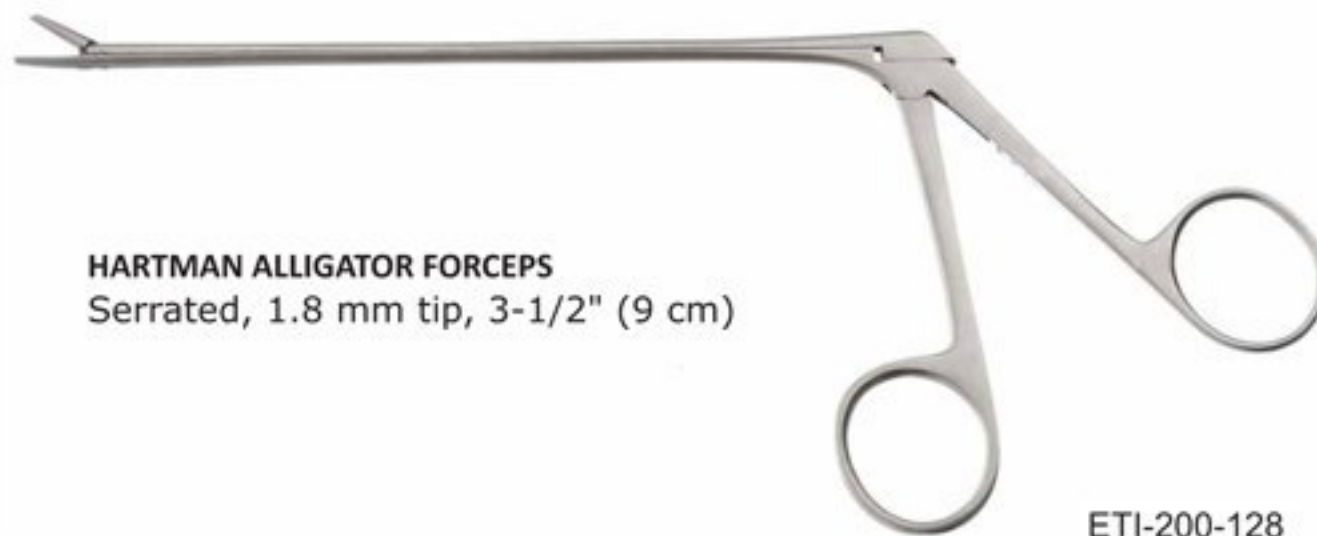

**HARTMAN ALLIGATOR FORCEPS**  
Serrated, 1.8 mm tip, 3-1/2" (9 cm)

ETI-200-128

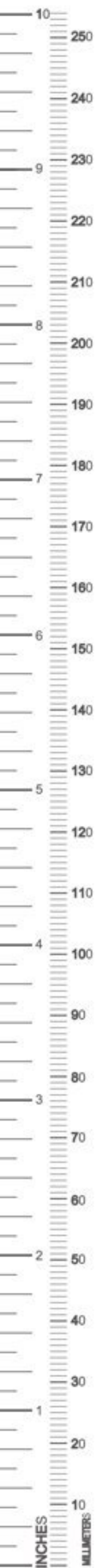



Care with Trust ...

**ENDO TECH**  
Instruments

### Ear polypus forceps, tampon forceps



**Hartmann-Wullstein**  
ETI-200-129



**Hartmann-Wullstein**  
ETI- -130 200



**Hartmann**  
ETI-200-131 = 8,5 cm  
ETI-200-132 = 14,0 cm  
ETI-200-133 = 16,0 cm

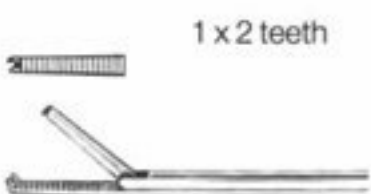

**Hartmann**  
ETI-200-134 = 8,5 cm  
ETI-200-135 = 14,0 cm



**Hartmann-Noyes**  
ETI-200-136 = 9 cm



ETI-200-137



**Weingärtner**  
ETI-200-138



**Strümpel**  
ETI-200-139



**Hartmann**  
ETI-200-140



**Hartmann**  
ETS-200-141 = 2,0 mm  
ETI-200- 142 = 2,5 mm  
ETI-200- 143 = 3,0 mm



**Hartmann**  
ETI-200-144 = 2,0 mm  
ETI-200-145 = 2,5 mm  
ETI-200-146 = 3,0 mm



**Hartmann**  
ETI-200-147



**Hartmann-Hoffmann**  
ETI-200-148

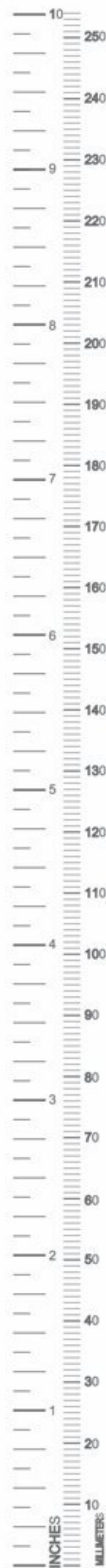



Care with Trust ...

**ENDO TECH**  
Instruments

### Malleus and crura nippers

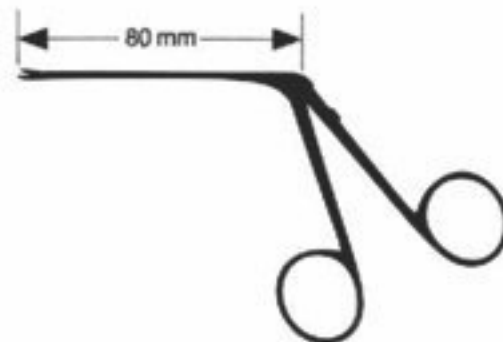

Malleus Nippers

Crura Nippers



ETI-200-149



ETI-200-151



ETI-200-152



ETI-200-150

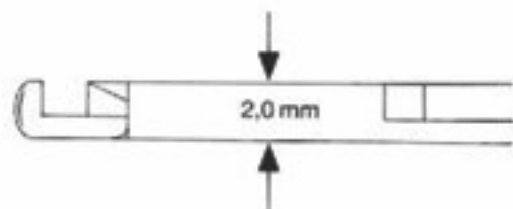

2,0 mm

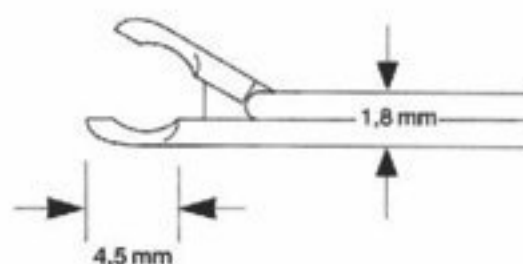

1,8 mm

4,5 mm

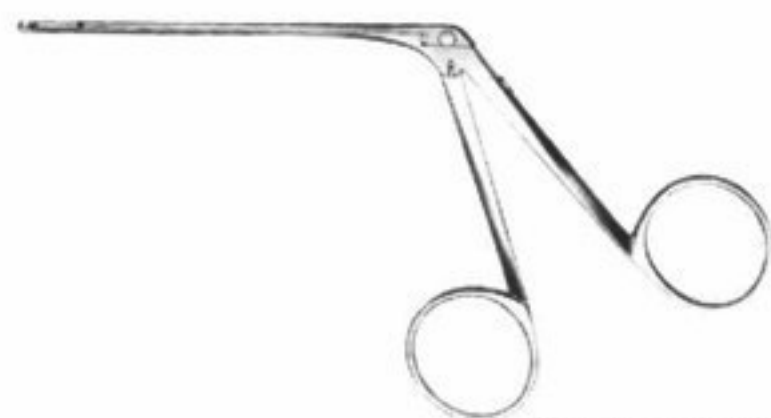

House-Dieter



Tabb  
ETI-200-153

Crura Nippers

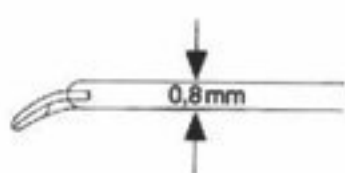

0,8 mm

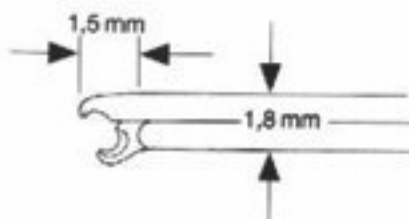

1,5 mm

1,8 mm

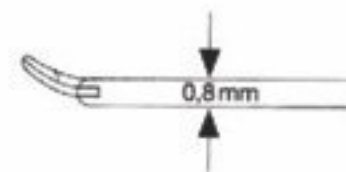

0,8 mm



left cutting

Fisch  
ETI-200-154



right cutting

Fisch  
ETI-200-155



Care with Trust ...

**ENDO TECH**  
Instruments

Wire crimpers, forceps for holding and inserting middle ear prothesis and drain tubes

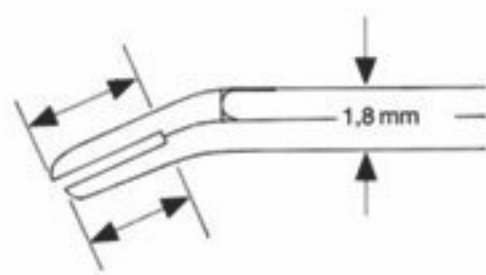

0,8x3,5 mm ETI-200-156

0,8x6,0 mm ETI-200-157

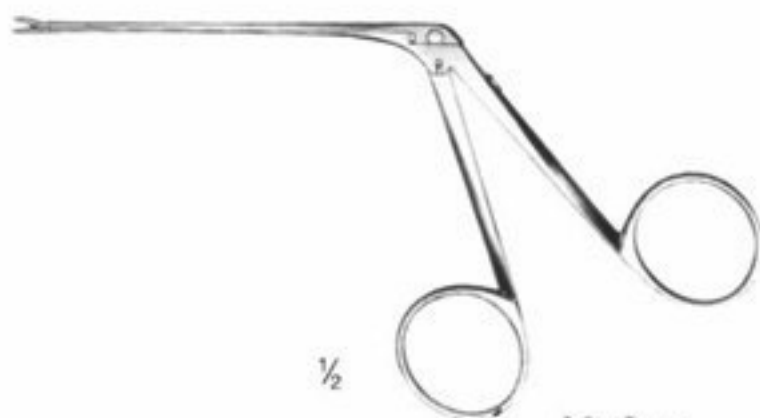

McGee

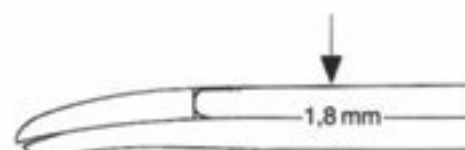
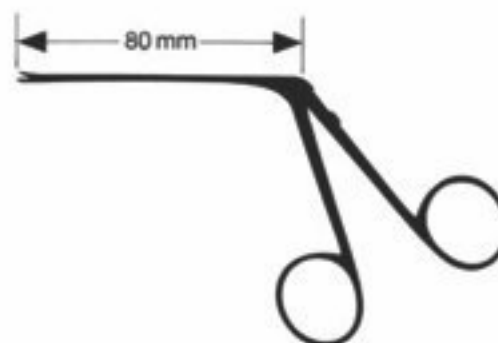

0,8x6,0 mm

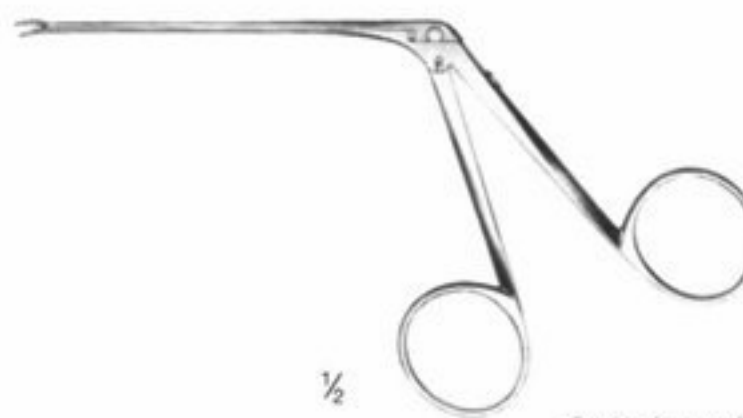

Schuknecht  
ETI-200-158

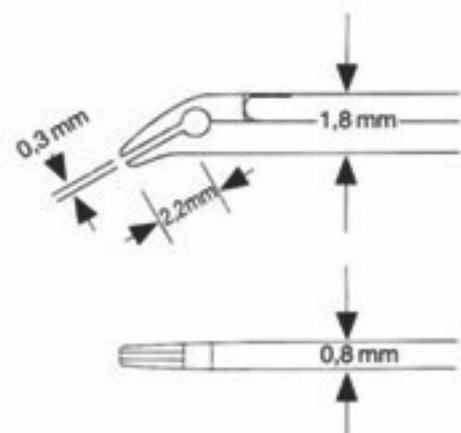

Fisch  
ETI-200-159

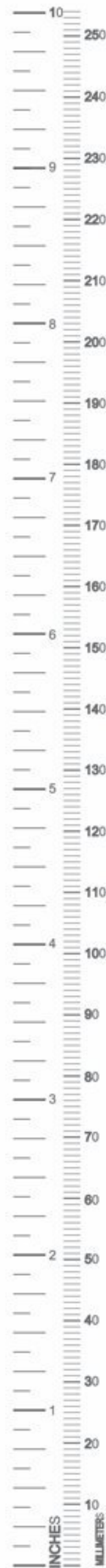



Care with Trust ...

**ENDO TECH**  
Instruments

Wire crimpers, forceps for holding and inserting middle ear prothesis and drain tubes

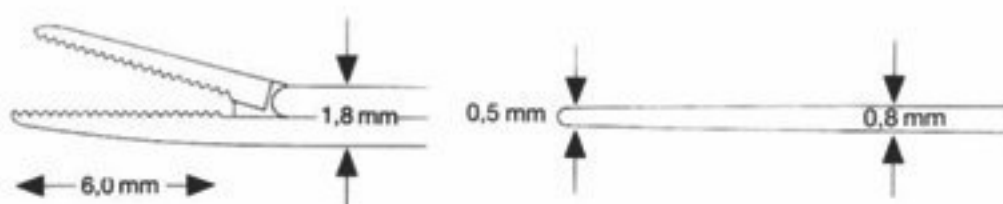

ETI-200-160

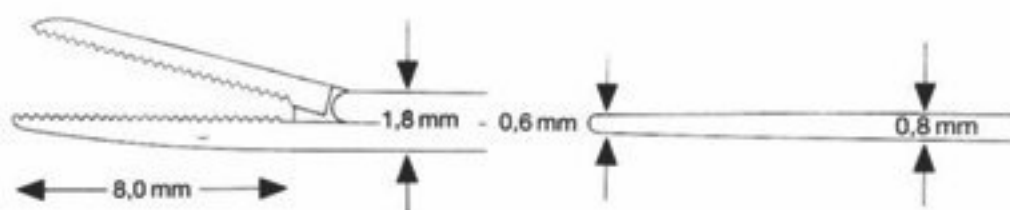
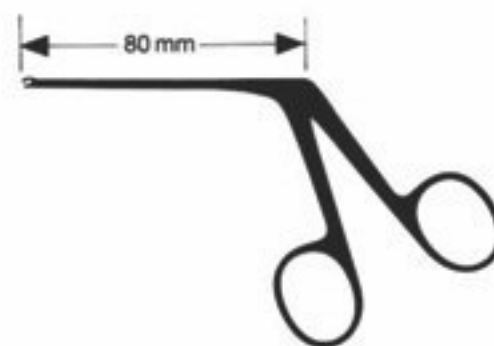

ETI-200-161

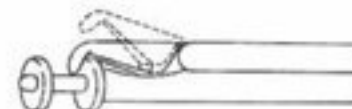
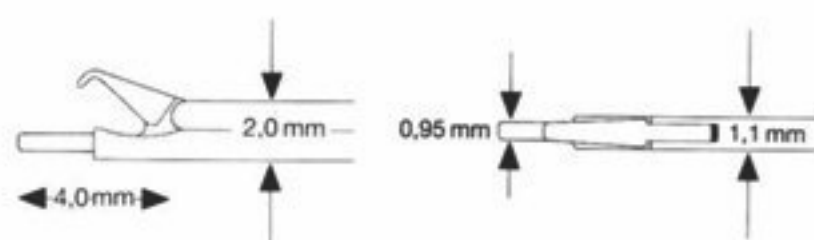

for Ventilation Tubes

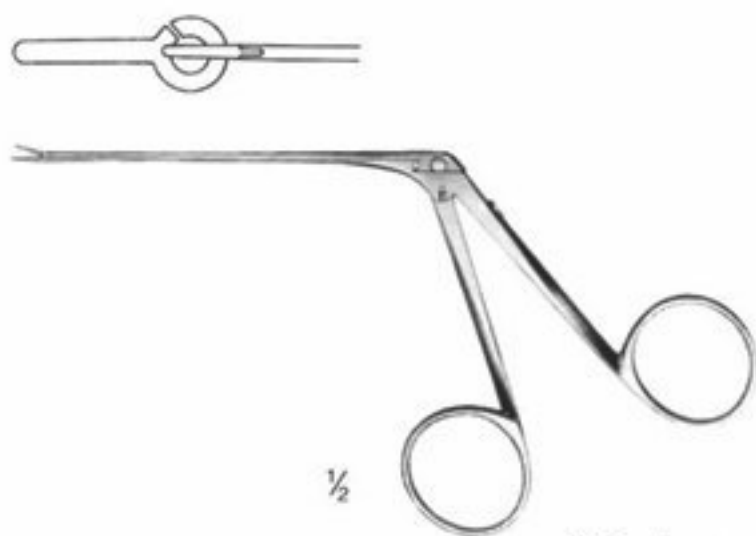

**Alligator**  
delicate  
ETI-200-162

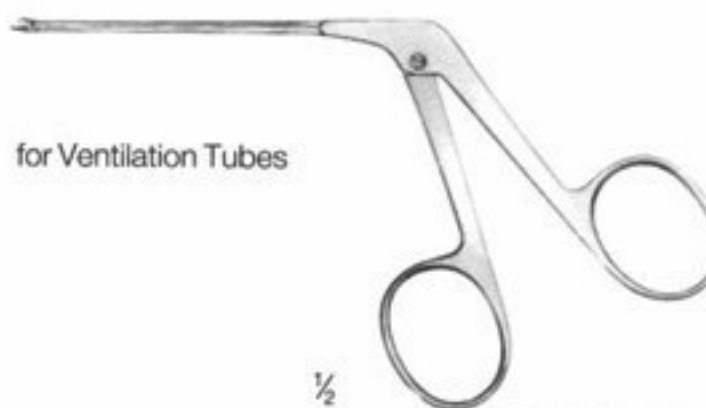

ETI-200-163

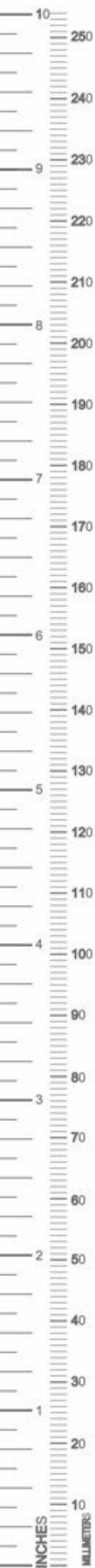



Care with Trust ...

**ENDO TECH**  
Instruments

**Micro ear scissors, bellucci-type, alligator action**



Bellucci

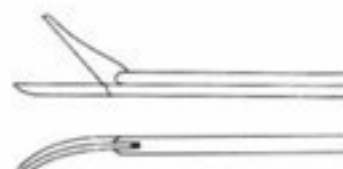
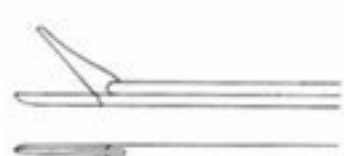
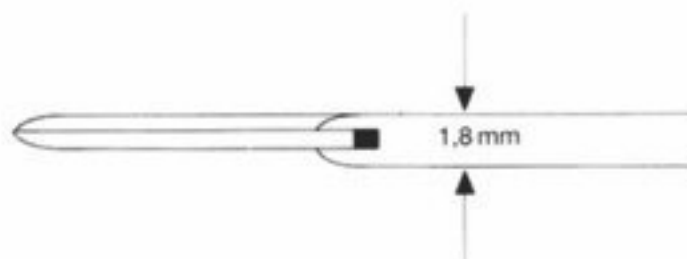
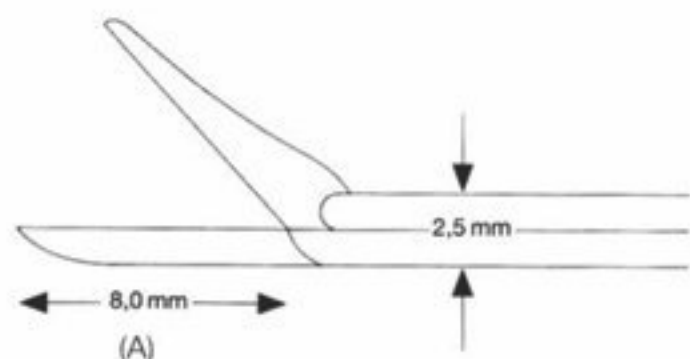
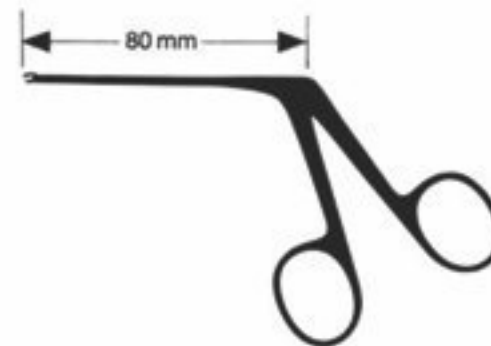

straight  
sharp/blunt      sharp/sharp  
delicate  
ETI-200-164      ETI-200-165

curved up  
sharp/sharp  
curved to left  
sharp/sharp  
ETI-200-166 (A = 6,0 mm)      ETI-200-167

curved to right  
sharp/sharp  
ETI-200-168

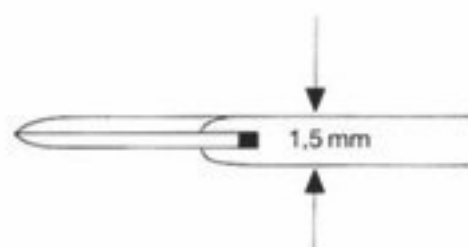
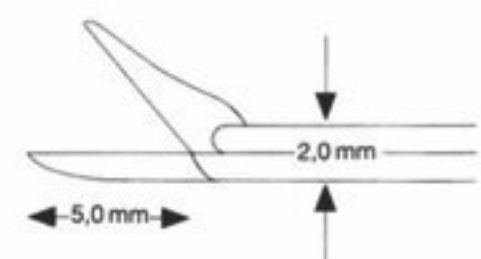

very delicate  
ETI-200-169      ETI-200-170

ETI-200-171 (A = 4,5 mm)      ETI-200-172

ETI-200-173

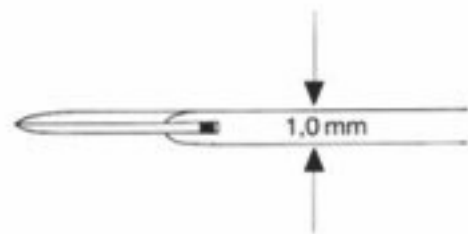
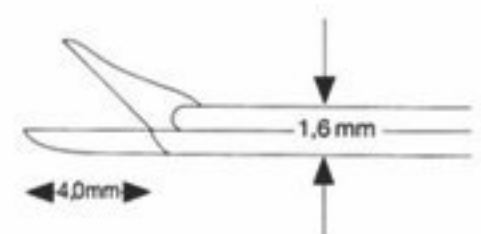

extra delicate  
ETI-200-174      ETI-200-175

ETI-200-176

ETI-200-177

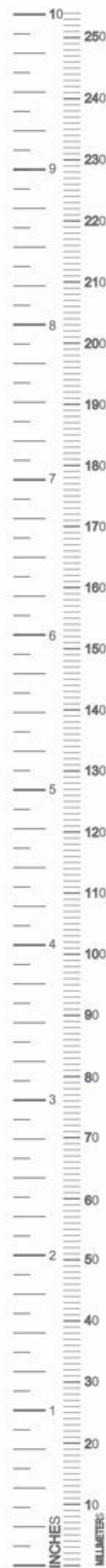



Care with Trust ...

**ENDO TECH**  
Instruments

**Micro ear forceps with tubular shafts**

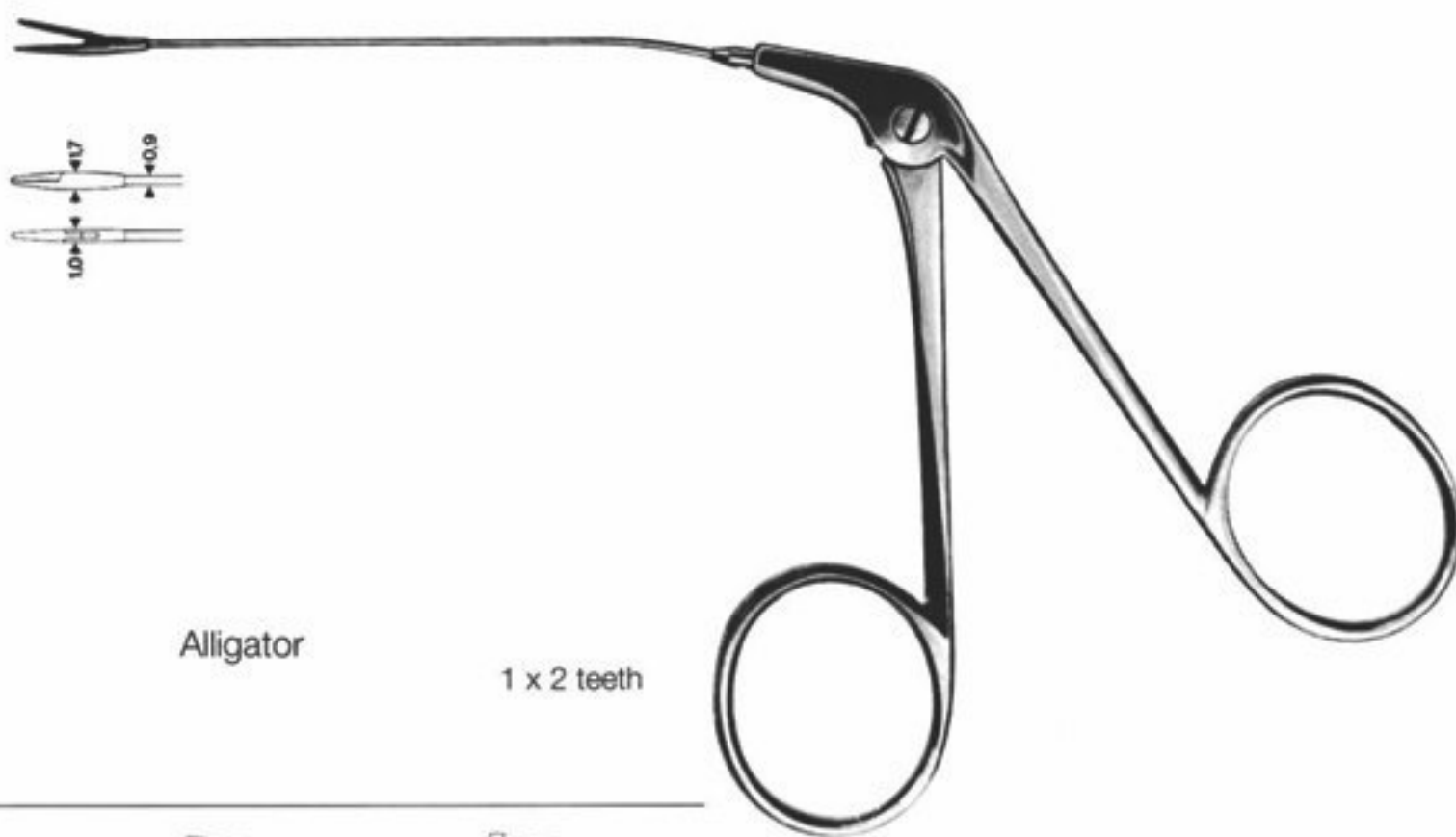

grasping

Alligator

1 x 2 teeth

|                                    |             |             |             |
|------------------------------------|-------------|-------------|-------------|
| straight                           | ETI-200-178 | ETI-200-182 | ETI-200-186 |
| angled up                          | ETI-200-179 | ETI-200-183 | ETI-200-187 |
| curved left                        | ETI-200-180 | ETI-200-184 |             |
| curved right                       | ETI-200-181 | ETI-200-185 |             |
| <b>Delicate Cup-shaped Forceps</b> |             |             |             |
| straight                           | ETI-200-188 | ETI-201-192 |             |
| angled up                          | ETI-200-189 | ETI-201-193 |             |
| curved left                        | ETI-200-190 | ETI-201-194 |             |
| curved right                       | ETI-200-191 | ETI-201-195 |             |

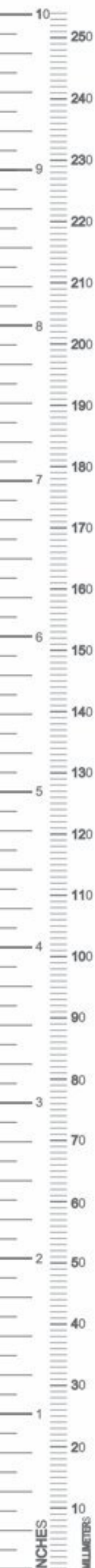



Care with Trust ...

**ENDO TECH**  
Instruments

Micro ear forceps with tubular shafts

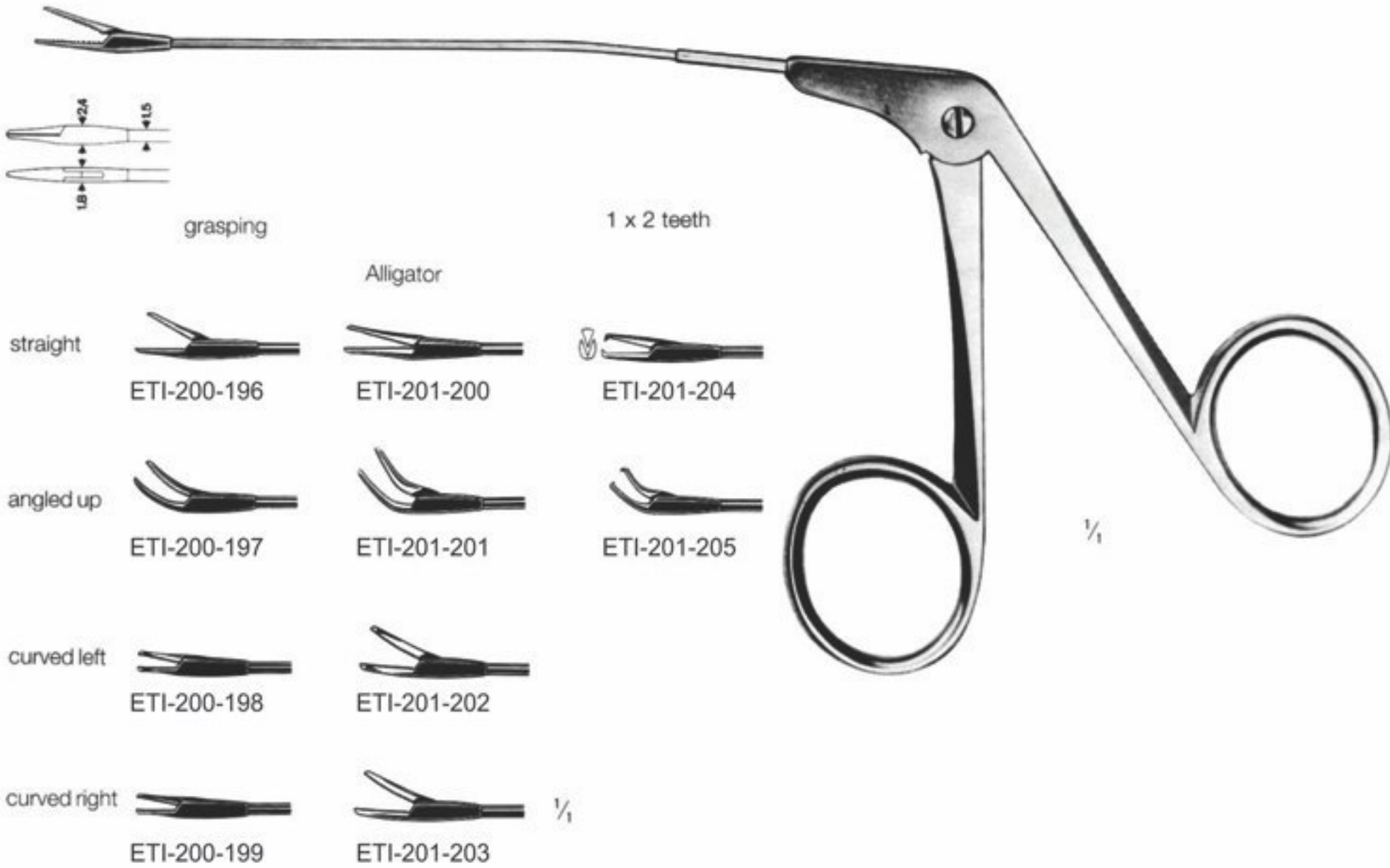

|              | grasping    | Alligator                 | 1 x 2 teeth |
|--------------|-------------|---------------------------|-------------|
| straight     | ETI-200-196 | ETI-201-200               | ETI-201-204 |
| angled up    | ETI-200-197 | ETI-201-201               | ETI-201-205 |
| curved left  | ETI-200-198 | ETI-201-202               |             |
| curved right | ETI-200-199 | ETI-201-203 $\frac{1}{1}$ |             |

Delicate Cup-shaped Forceps

|              | Ø 1 mm                    | Ø 1,5 mm    | Ø 2 mm      | Ø 2,5 mm    | oval        |
|--------------|---------------------------|-------------|-------------|-------------|-------------|
| straight     | ETI-201-206               | ETI-201-110 | ETI-201-114 | ETI-201-118 | ETI-201-122 |
| angled up    | ETI-201-207               | ETI-201-111 | ETI-201-115 | ETI-201-119 | ETI-201-123 |
| curved left  | ETI-201-208               | ETI-201-112 | ETI-201-116 | ETI-201-120 | ETI-201-124 |
| curved right | ETI-201-209 $\frac{1}{1}$ | ETI-201-113 | ETI-201-117 | ETI-201-121 | ETI-201-125 |

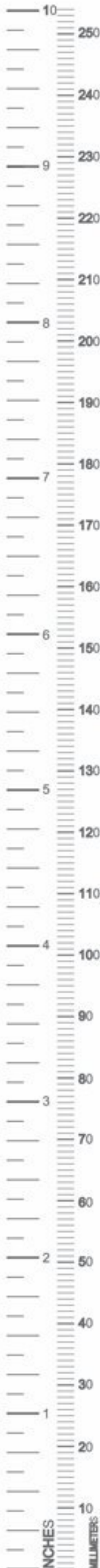



Care with Trust ...

**ENDO TECH**  
Instruments

**Micro ear scissors with tubular shafts**

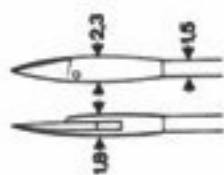
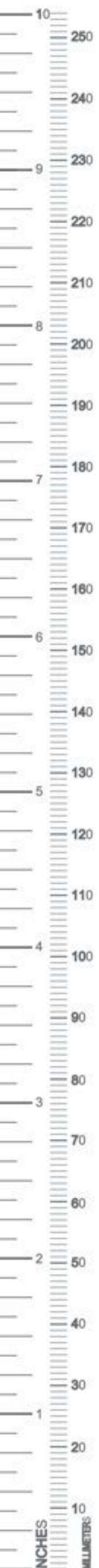

straight ETS-201-126



angled up ETS-201-127



curved left ETS-201-128



curved right ETS-201-129



horizontal straight ETS-201-130



angled up ETS-201-131

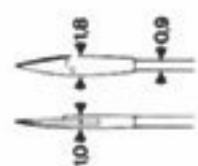

straight ETS-201-132



angled up ETS-201-133



curved left ETS-201-134



curved right ETS-201-135



horizontal straight ETS-201-136



angled up ETS-201-137



mini-micro



Care with Trust ...

**ENDO TECH**  
Instruments

**LARYNGEAL INSTRUMENTS**



ETI-201-138



ETI-201-139

**Laryngeal GRASPING FORCEPS**  
Straight, serrated, 11" (28 cm)

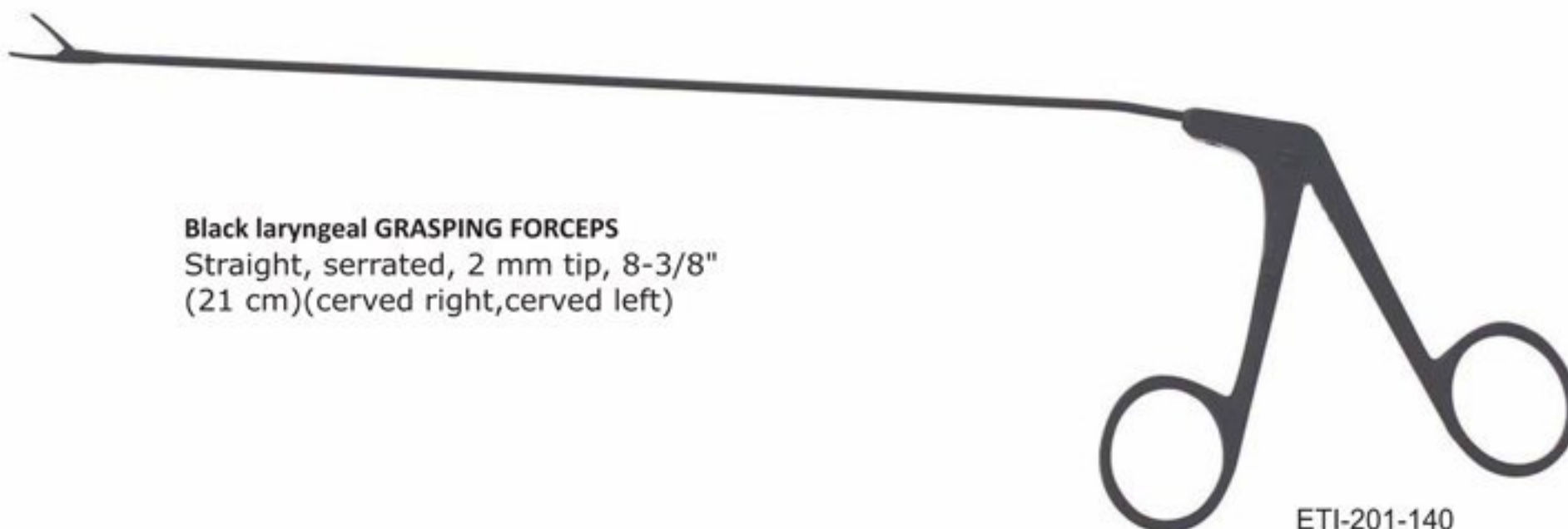

ETI-201-140

**Black laryngeal GRASPING FORCEPS**  
Straight, serrated, 2 mm tip, 8-3/8"  
(21 cm)(cervd right,cervd left)

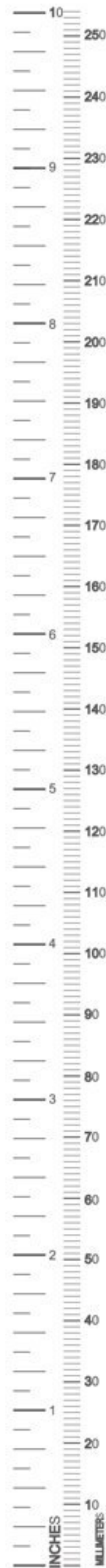



Care with Trust ...

**ENDO TECH**  
Instruments

**LARYNGEAL INSTRUMENTS**



ETI-201-141

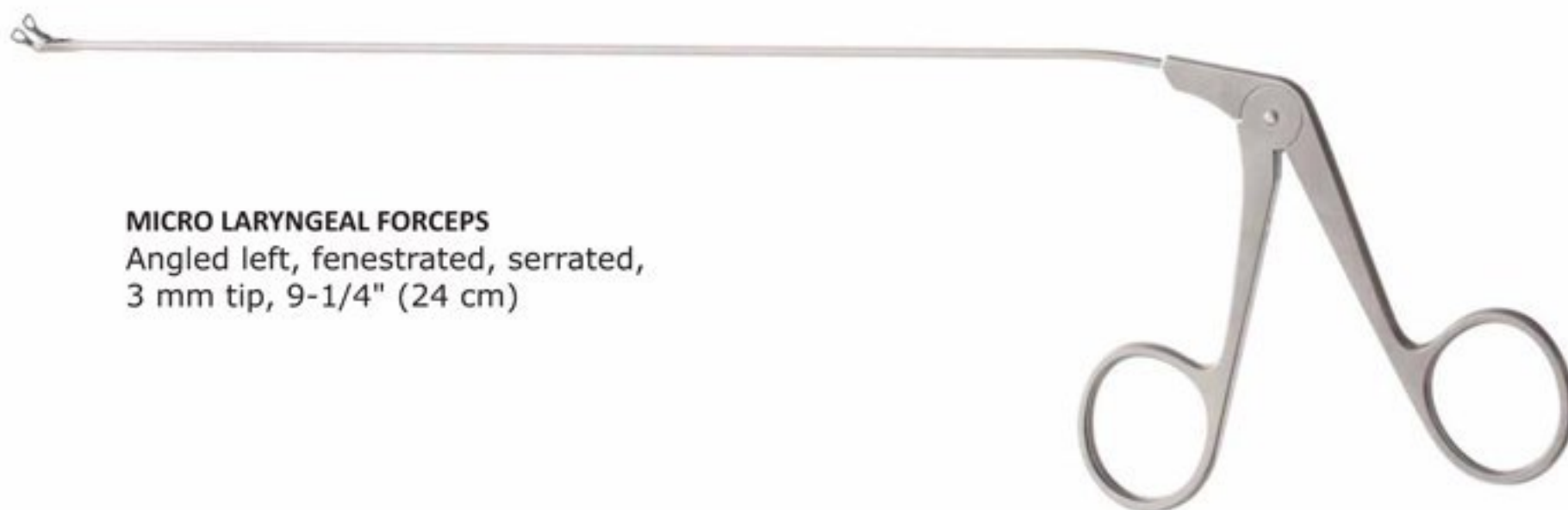

**MICRO LARYNGEAL FORCEPS**  
Angled left, fenestrated, serrated,  
3 mm tip, 9-1/4" (24 cm)

ETI-201-142



ETI-201-143

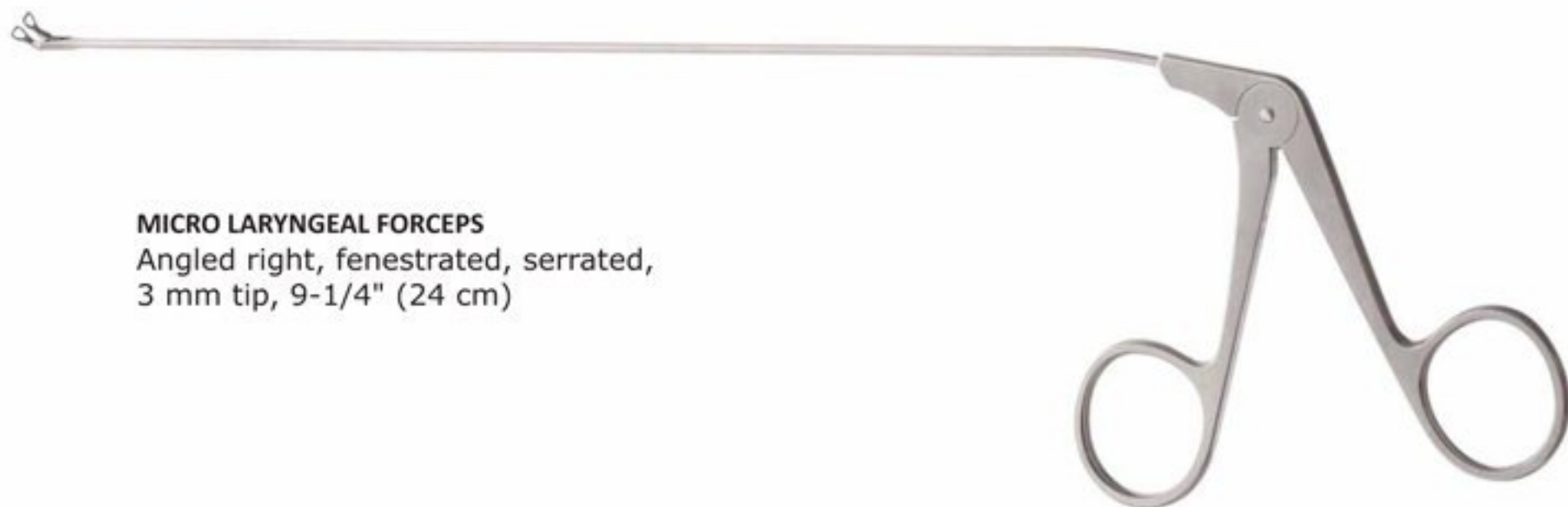

**MICRO LARYNGEAL FORCEPS**  
Angled right, fenestrated, serrated,  
3 mm tip, 9-1/4" (24 cm)

ETI-201-144

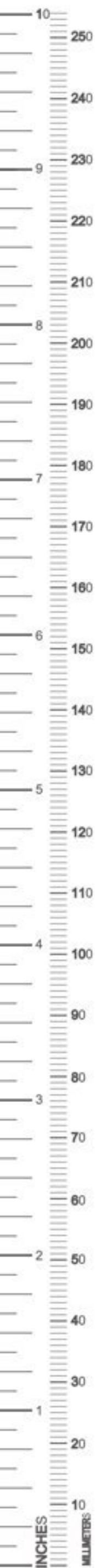



Care with Trust ...

**ENDO TECH**  
Instruments

**LARYNGEAL INSTRUMENTS**

ETI-201-145



**MICRO LARYNGEAL CUP FORCEPS**  
Straight, Round biopsy cups w/ 1 mm jaw, 9" (23 cm)

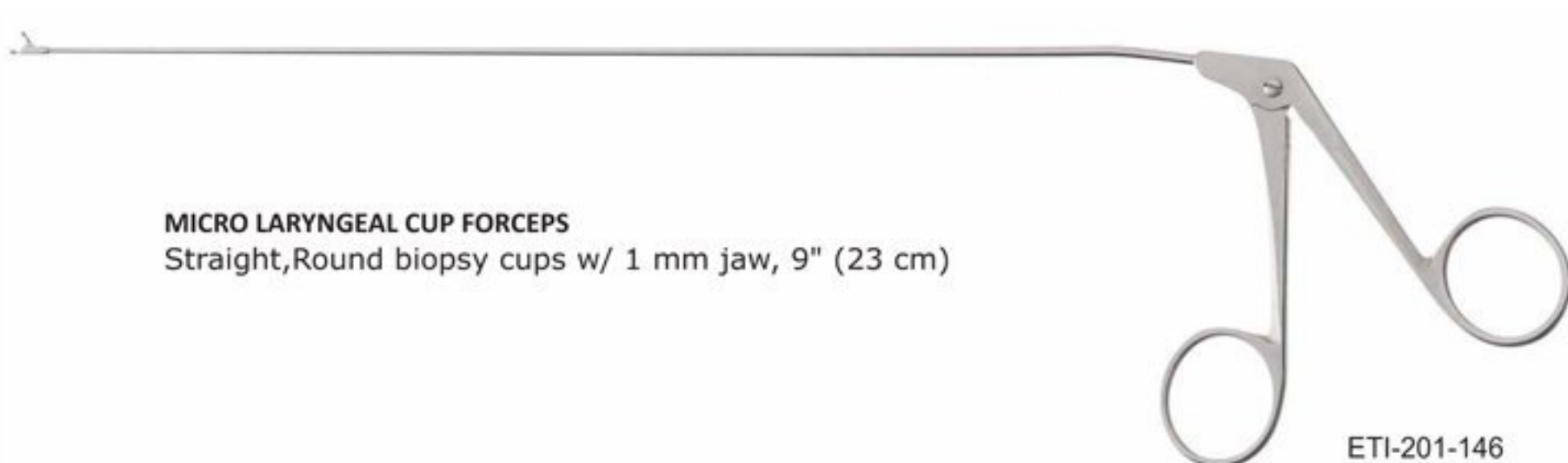

ETI-201-146

**MICRO LARYNGEAL CUP FORCEPS**  
Angled up, Round biopsy cups w/ 1 mm jaw, 9" (23 cm)

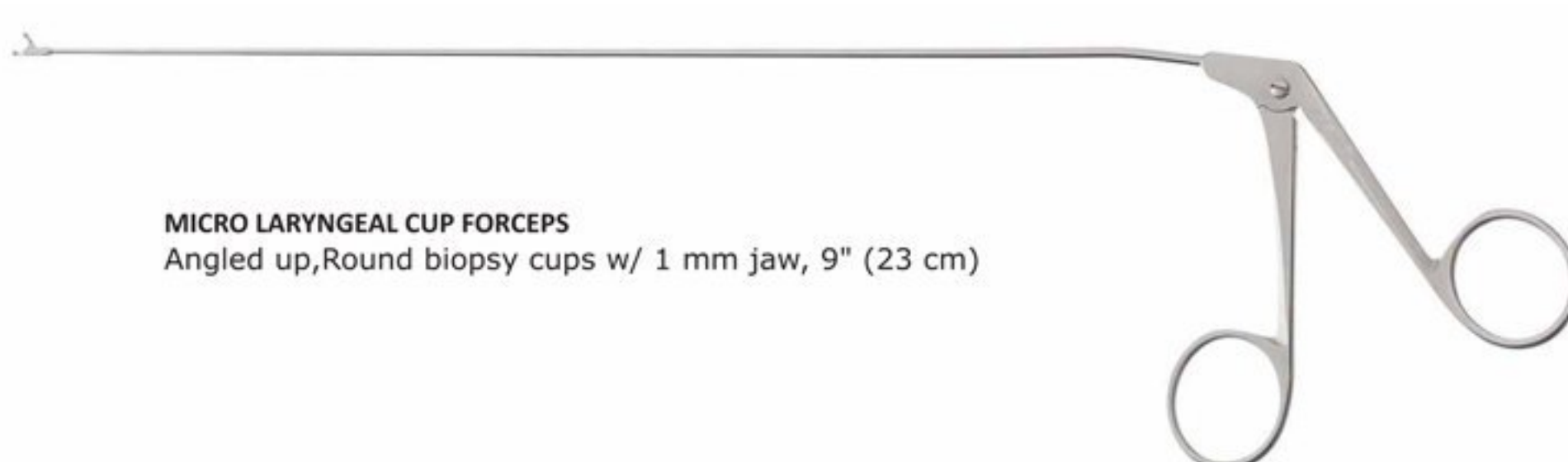

ETI-201-147

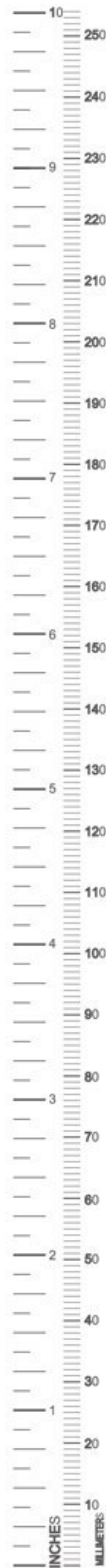



Care with Trust ...

**ENDO TECH**  
Instruments

**LARYNGEAL INSTRUMENTS**

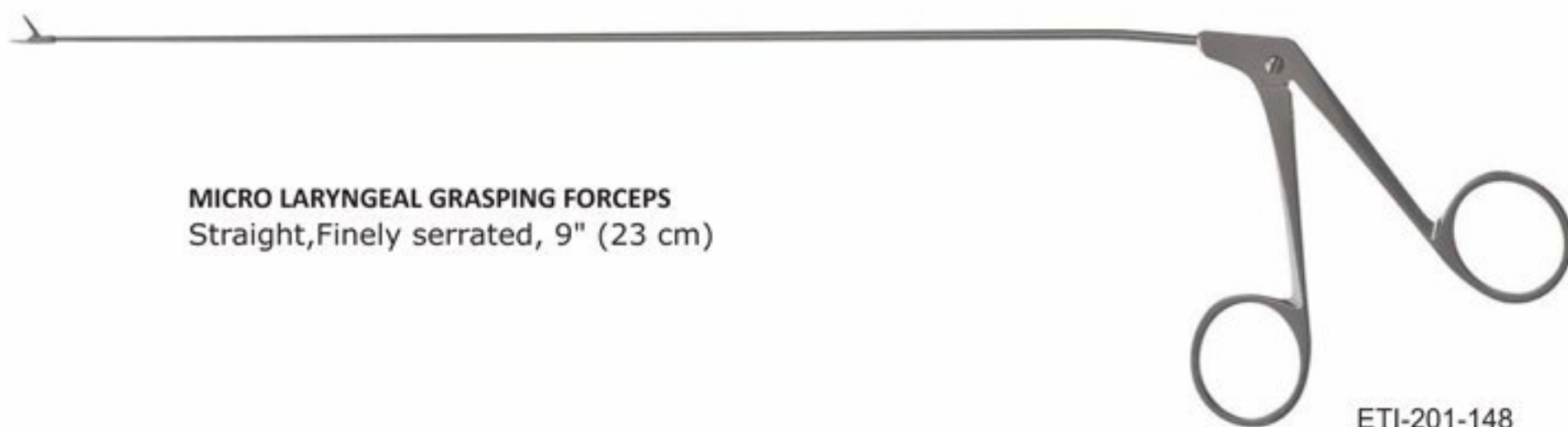

**MICRO LARYNGEAL GRASPING FORCEPS**  
Straight, Finely serrated, 9" (23 cm)

ETI-201-148

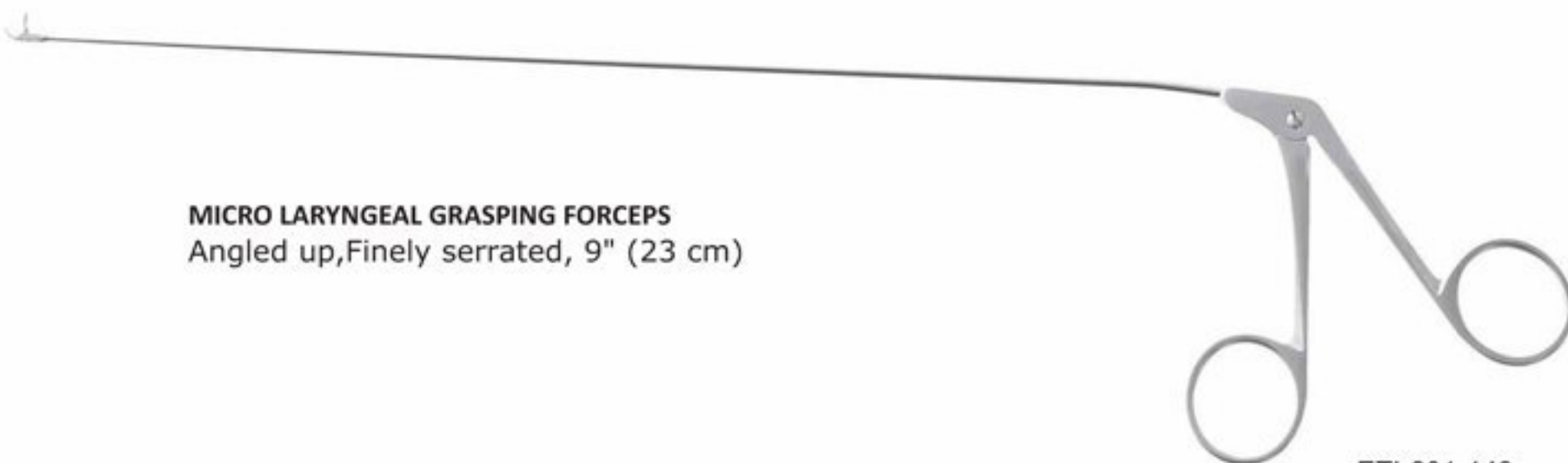

**MICRO LARYNGEAL GRASPING FORCEPS**  
Angled up, Finely serrated, 9" (23 cm)

ETI-201-149

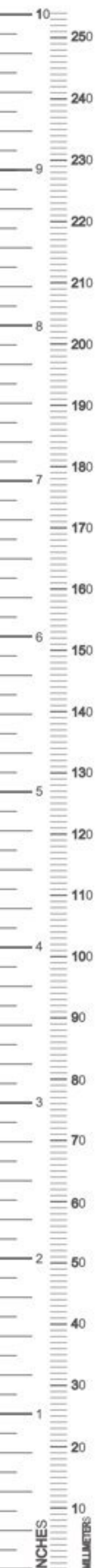



Care with Trust ...

**ENDO TECH**  
Instruments

**LARYNGEAL INSTRUMENTS**

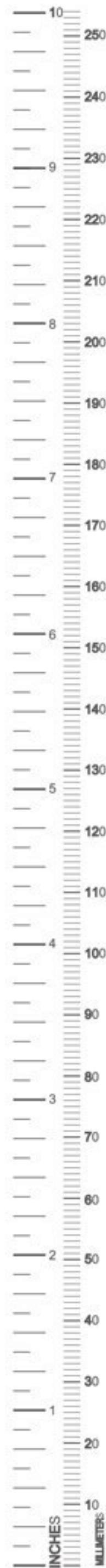
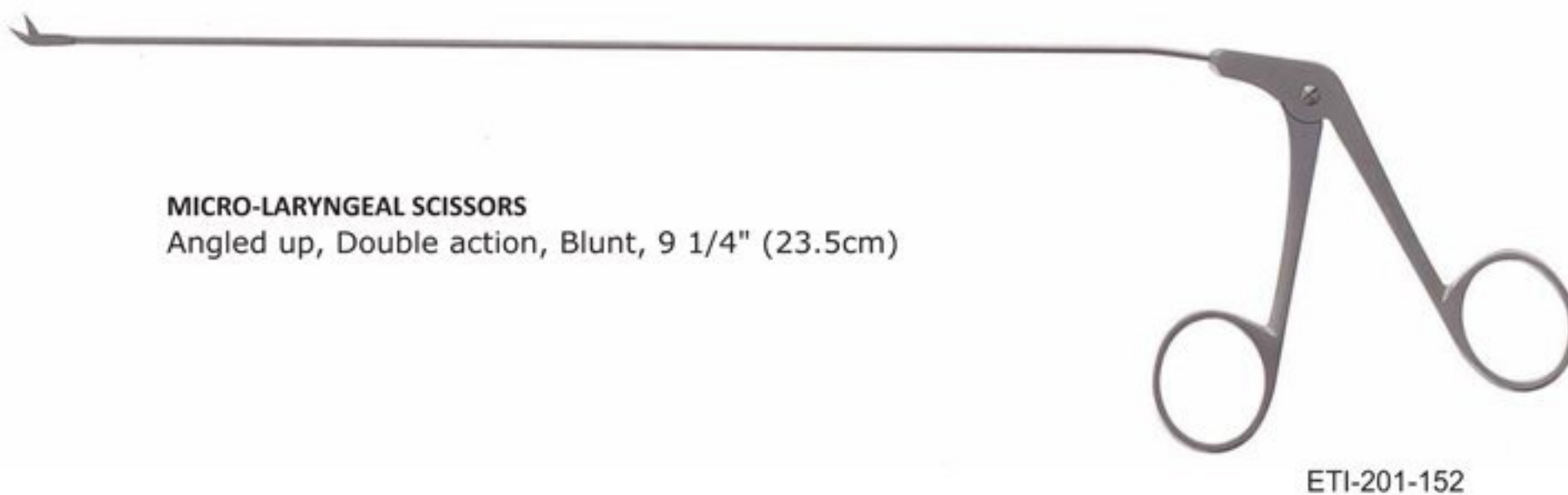
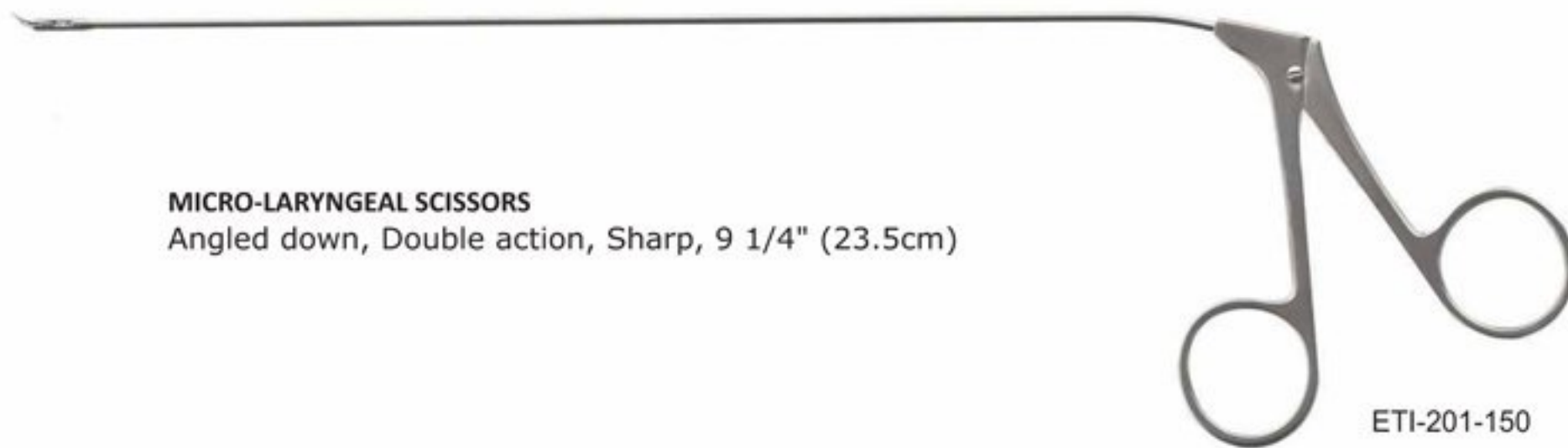



Care with Trust ...

**ENDO TECH**  
Instruments

**LARYNGEAL INSTRUMENTS**



ETI-201-153

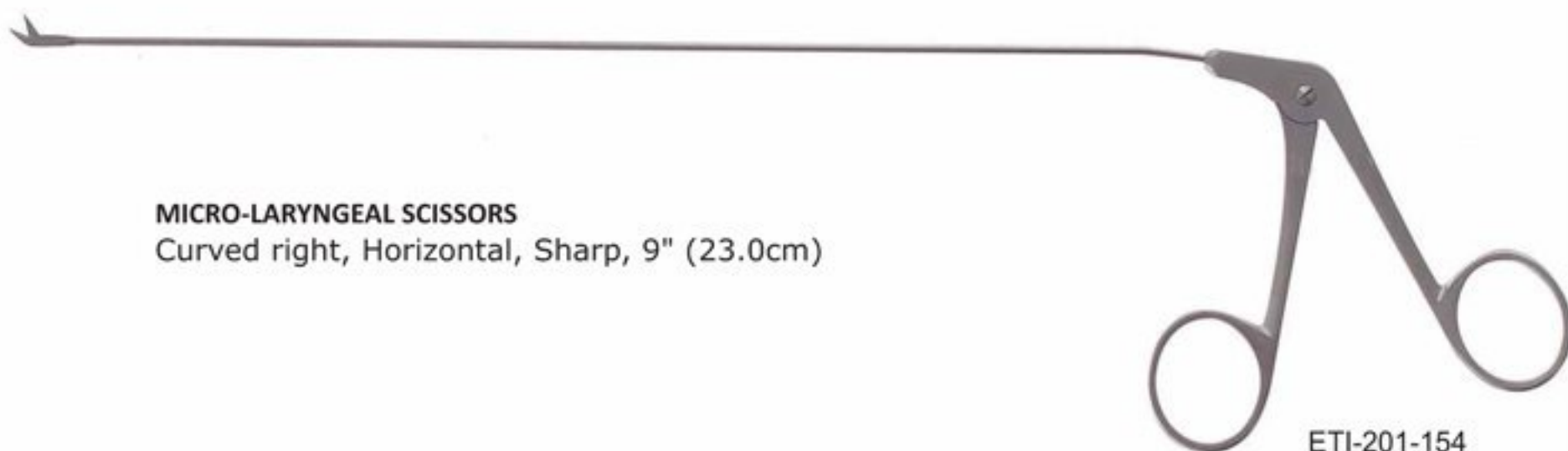

**MICRO-LARYNGEAL SCISSORS**  
Curved right, Horizontal, Sharp, 9" (23.0cm)

ETI-201-154

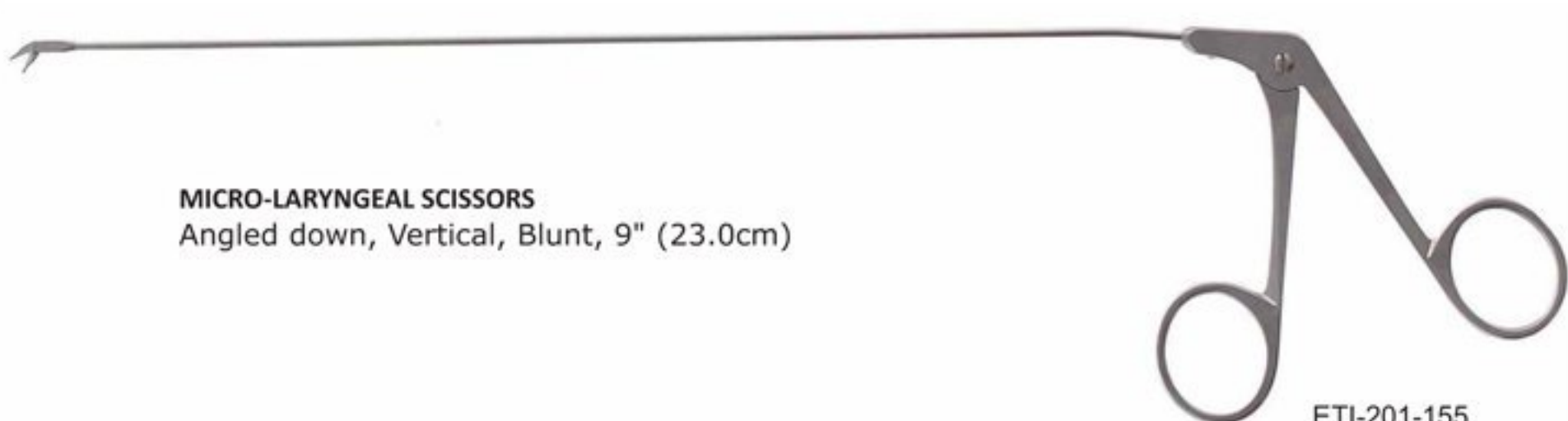

**MICRO-LARYNGEAL SCISSORS**  
Angled down, Vertical, Blunt, 9" (23.0cm)

ETI-201-155

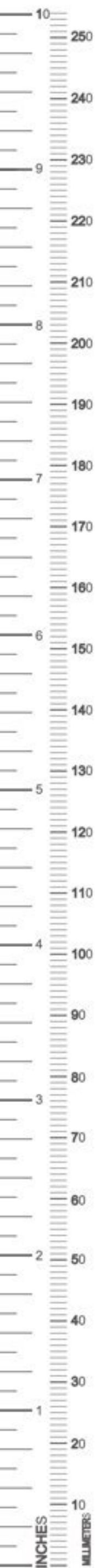



Care with Trust ...

**ENDO TECH**  
Instruments

**LARYNGEAL INSTRUMENTS**

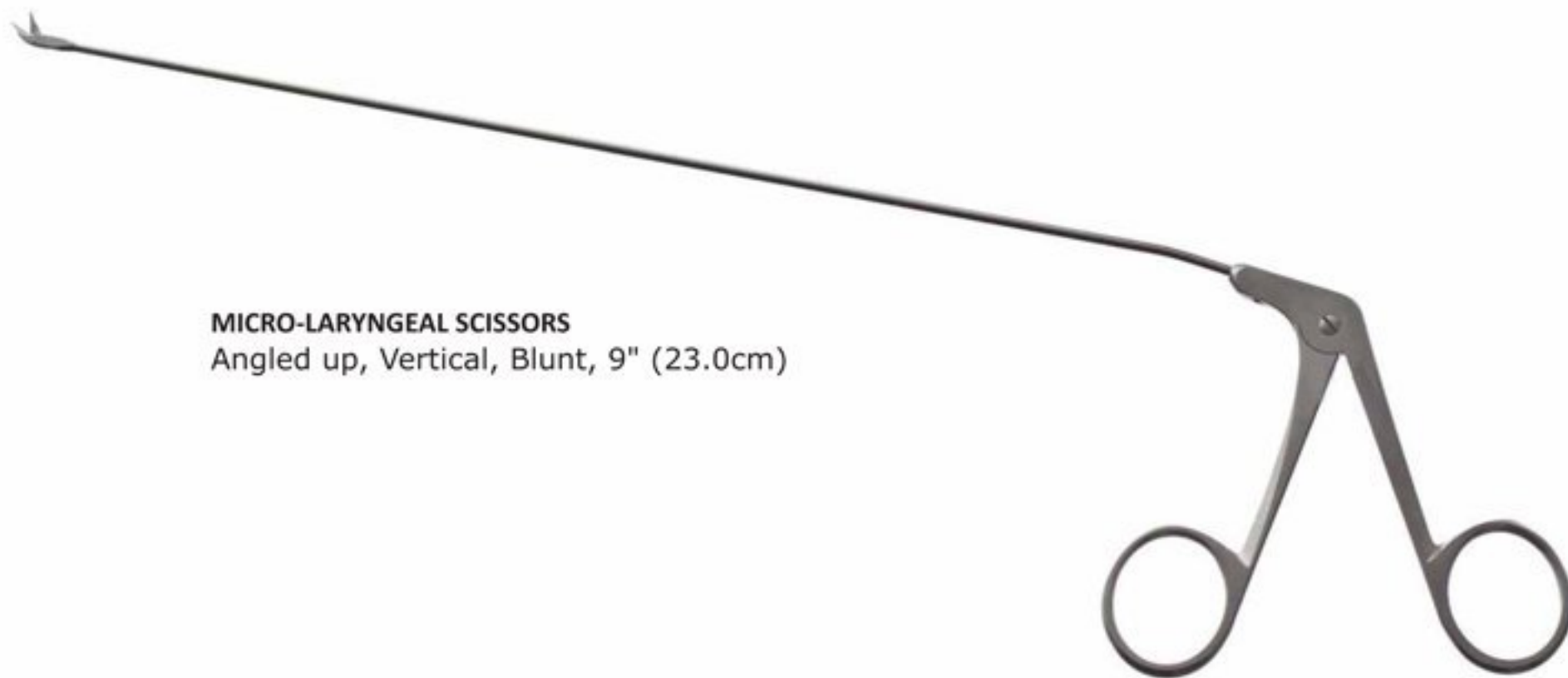

**MICRO-LARYNGEAL SCISSORS**  
Angled up, Vertical, Blunt, 9" (23.0cm)

ETI-201-156



**MICRO-LARYNGEAL SCISSORS**  
Curved right, Horizontal, Blunt, 9" (23.0cm)

ETI-201-157

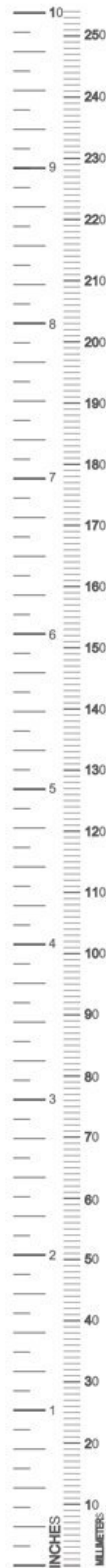



Care with Trust ...

**ENDO TECH**  
Instruments

**LARYNGEAL INSTRUMENTS**

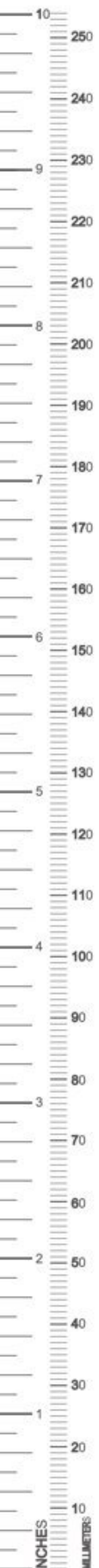
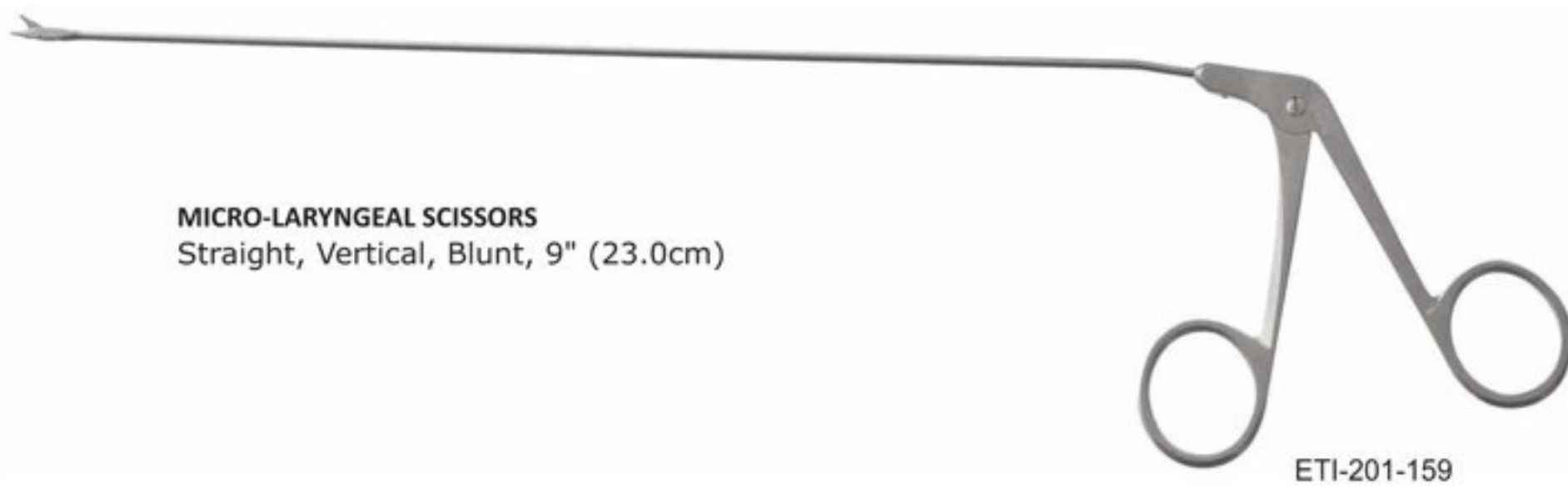
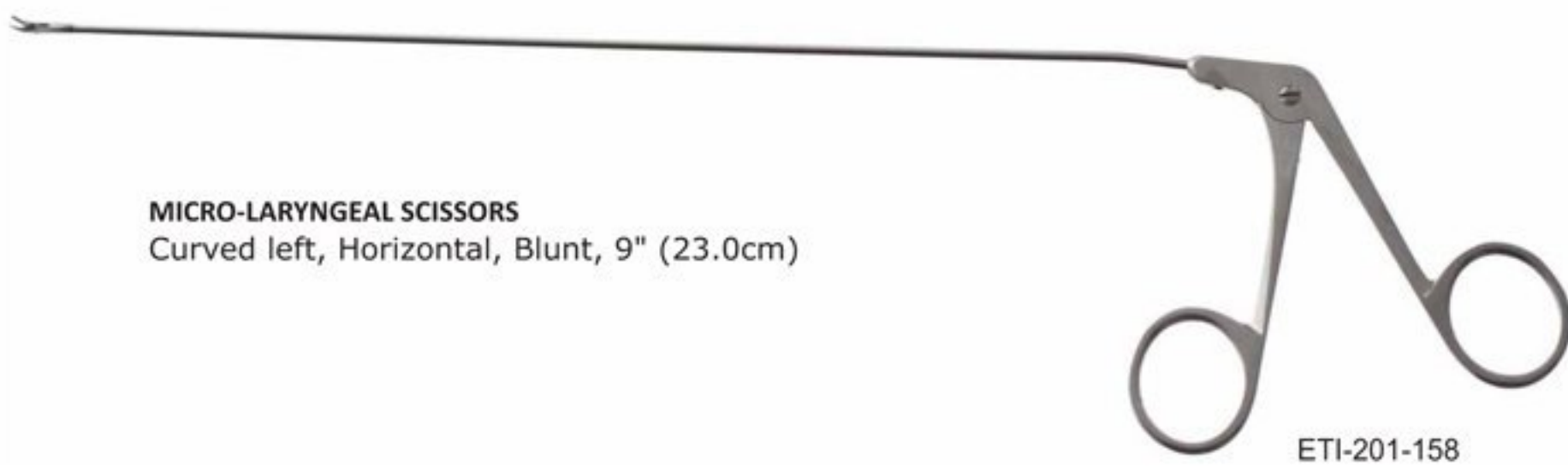



Care with Trust ...

**ENDO TECH**  
Instruments

**LARYNGEAL INSTRUMENTS**

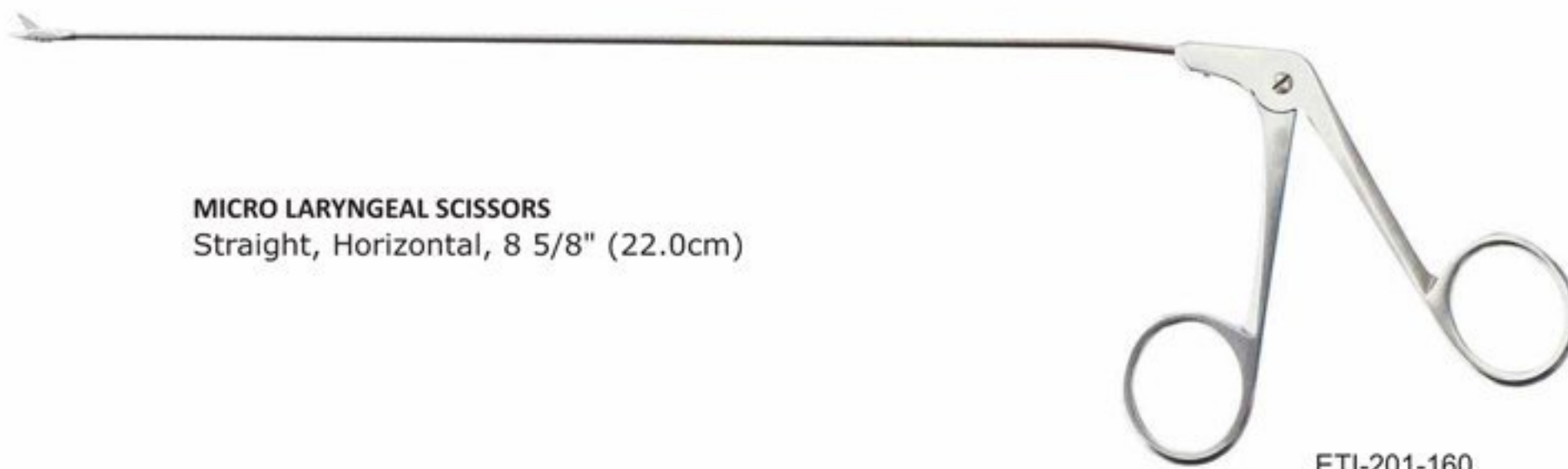

**MICRO LARYNGEAL SCISSORS**  
Straight, Horizontal, 8 5/8" (22.0cm)

ETI-201-160

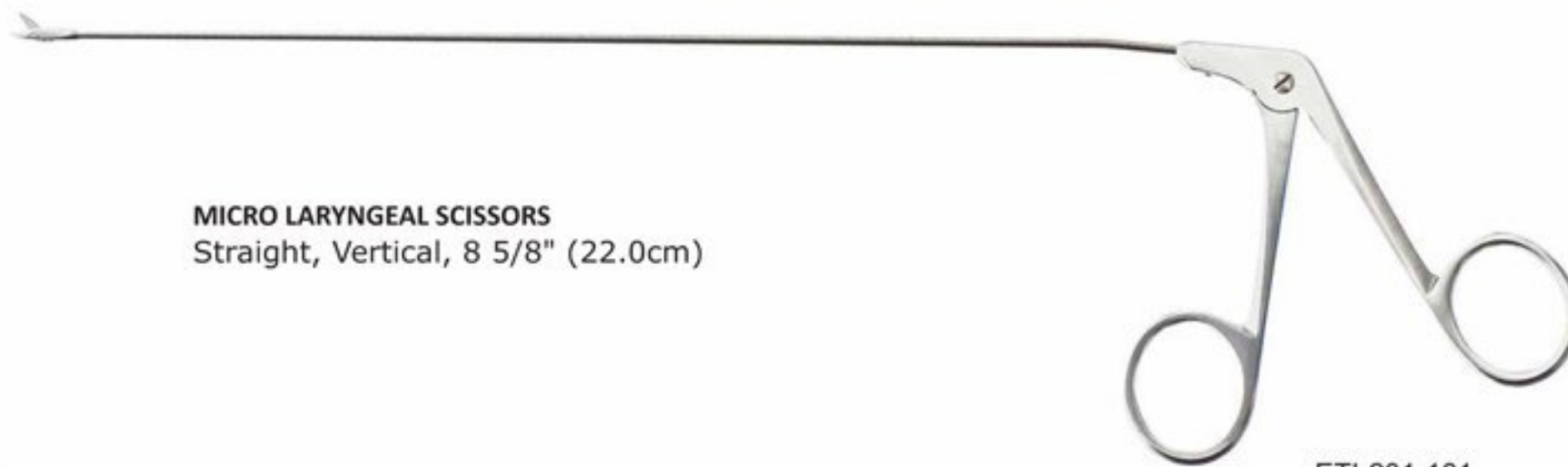

**MICRO LARYNGEAL SCISSORS**  
Straight, Vertical, 8 5/8" (22.0cm)

ETI-201-161

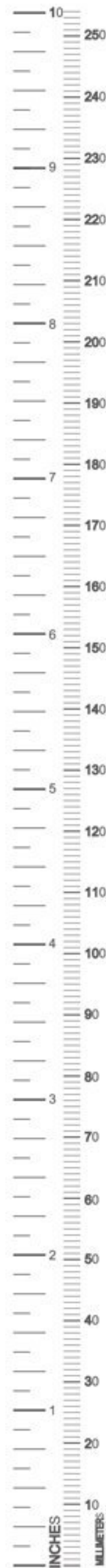



Care with Trust ...

**ENDO TECH**  
Instruments

**LARYNGEAL INSTRUMENTS**

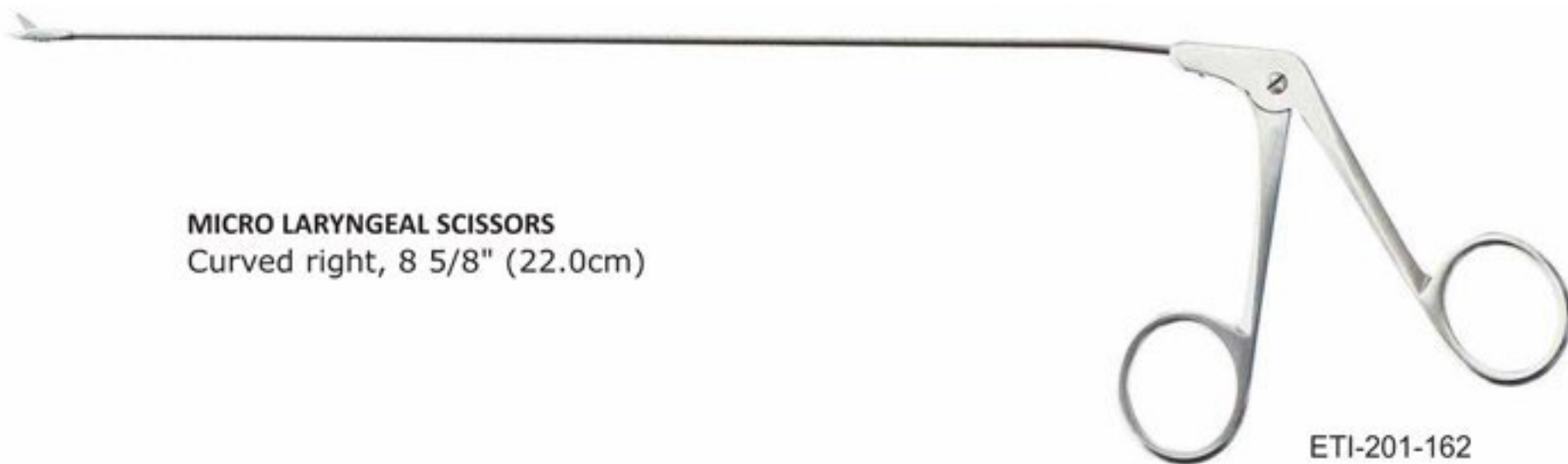

**MICRO LARYNGEAL SCISSORS**  
Curved right, 8 5/8" (22.0cm)

ETI-201-162



**MICRO LARYNGEAL SCISSORS**  
Curved left, 8 5/8" (22.0cm)

ETI-201-163

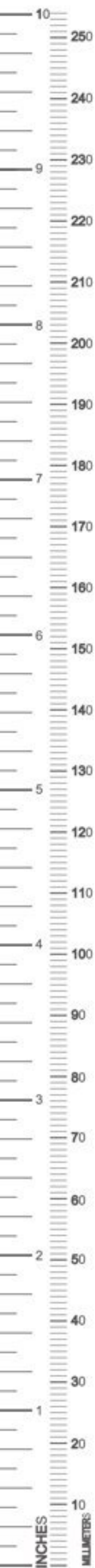



Care with Trust ...

**ENDO TECH**  
Instruments

**LARYNGEAL INSTRUMENTS**

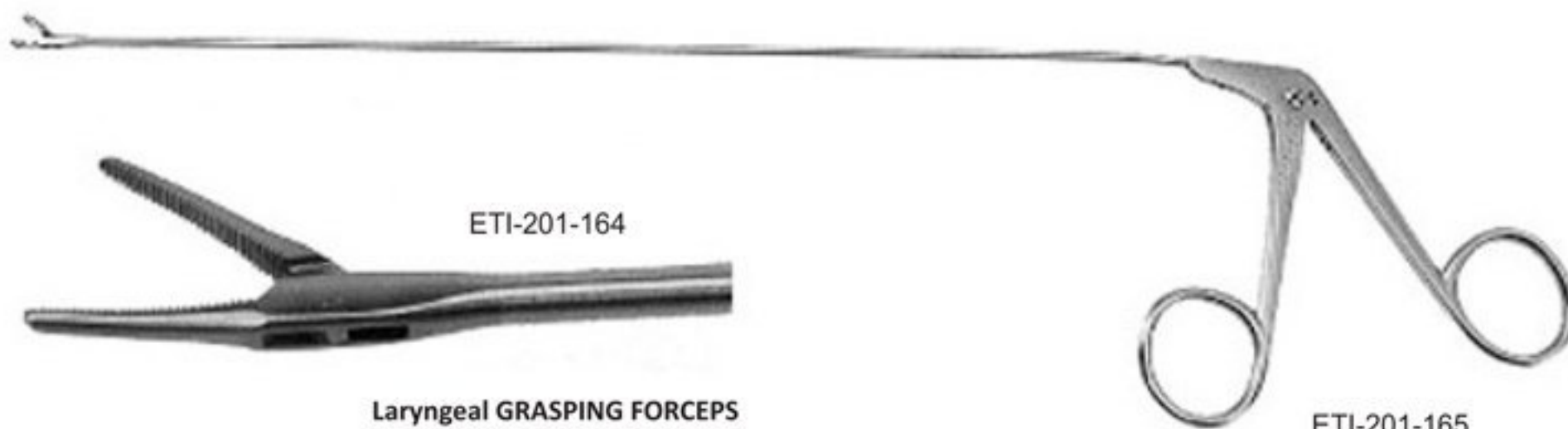

**Laryngeal GRASPING FORCEPS**  
Straight, very fine serrated, 5° bend, 22 cm

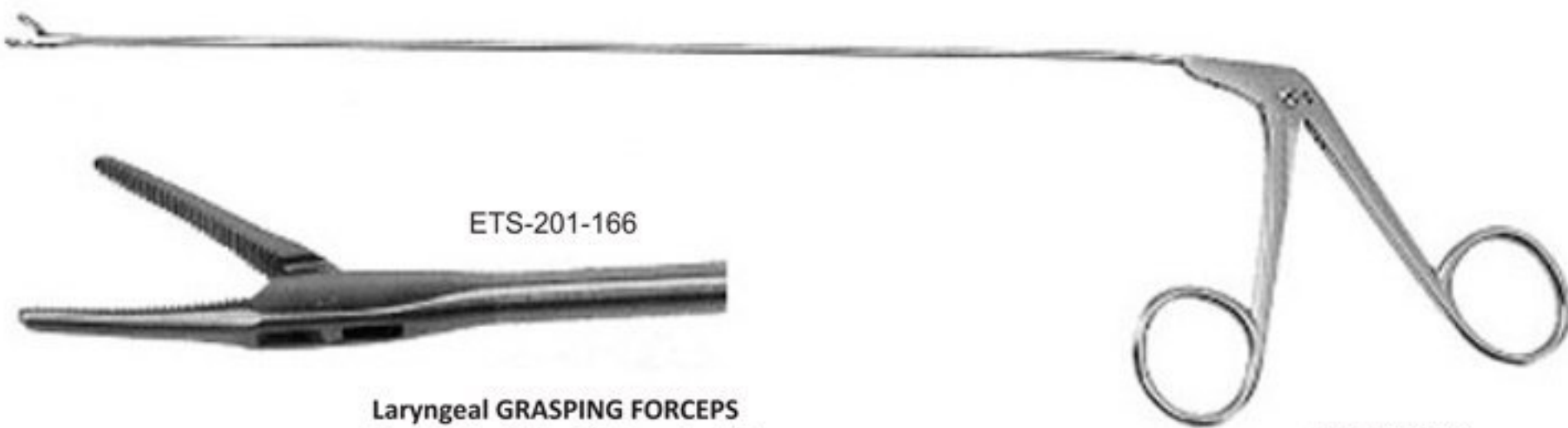

**Laryngeal GRASPING FORCEPS**  
Curved right, 5° bend, 22 cm

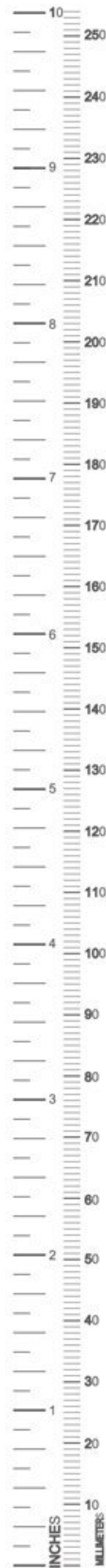



Care with Trust ...

**ENDO TECH**  
Instruments

**LARYNGEAL INSTRUMENTS**

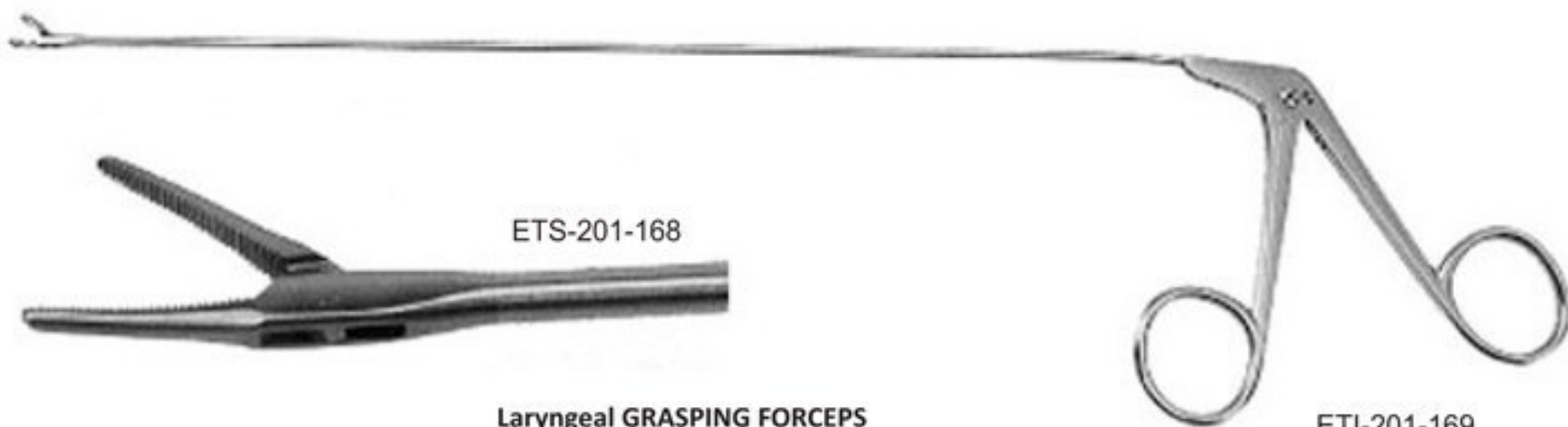

ETS-201-168

**Laryngeal GRASPING FORCEPS**  
Curved left, 5° bend, 22 cm

ETI-201-169

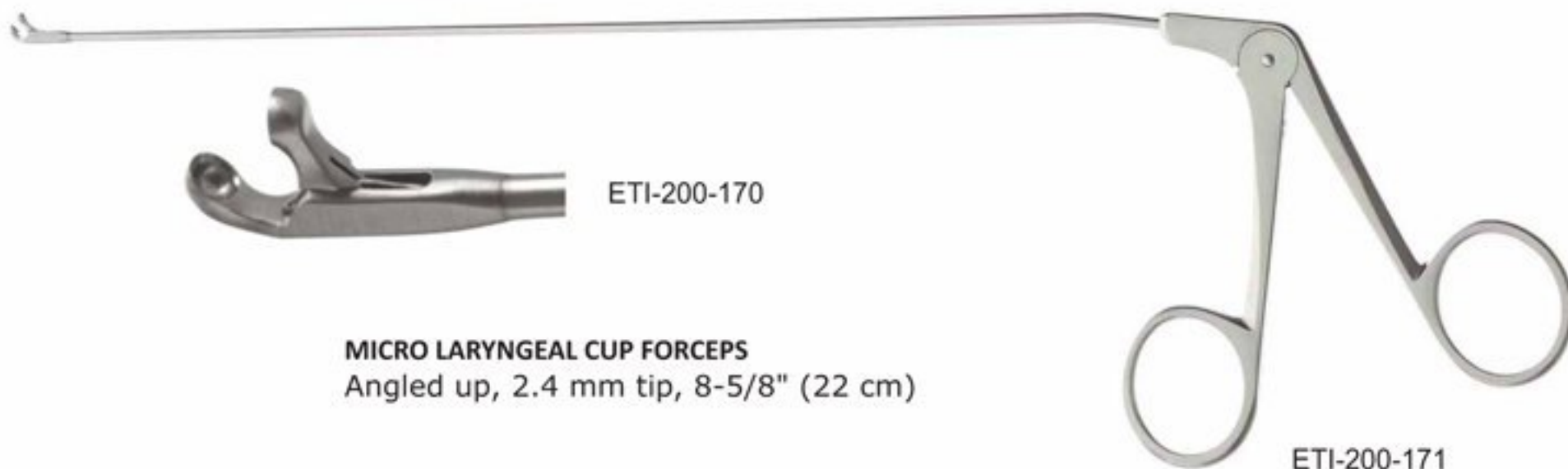

ETI-200-170

**MICRO LARYNGEAL CUP FORCEPS**  
Angled up, 2.4 mm tip, 8-5/8" (22 cm)

ETI-200-171

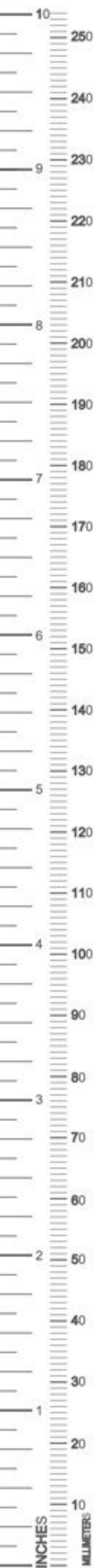



Care with Trust ...

**ENDO TECH**  
Instruments

**LARYNGEAL INSTRUMENTS**



**MICRO LARYNGEAL CUP FORCEPS**  
Straight, 8-5/8" (22 cm)

ETI-201-172

ETI-201-173

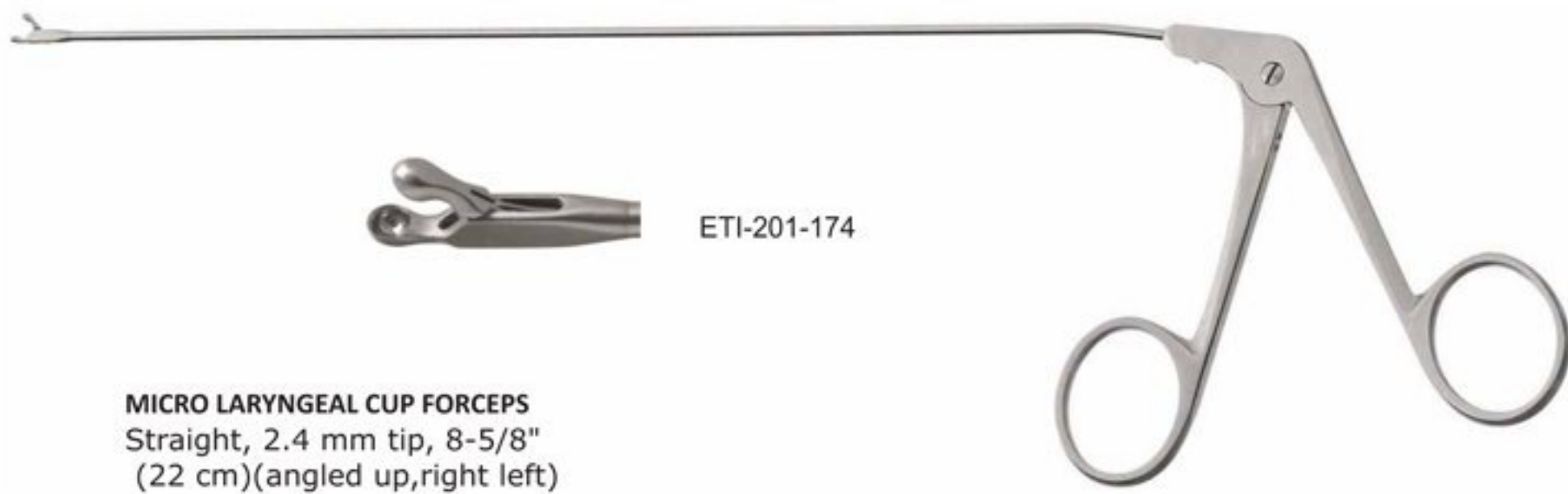

**MICRO LARYNGEAL CUP FORCEPS**  
Straight, 2.4 mm tip, 8-5/8"  
(22 cm)(angled up, right left)

ETI-201-174

ETI-201-175

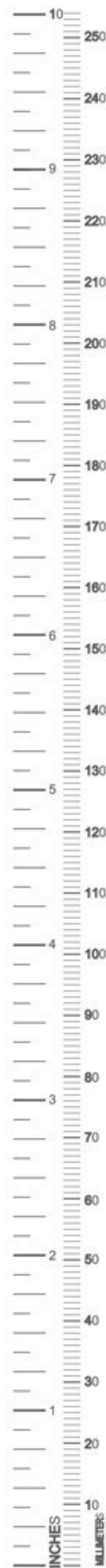



Care with Trust ...

**ENDO TECH**  
Instruments

**LARYNGEAL INSTRUMENTS**



ETI-201-176

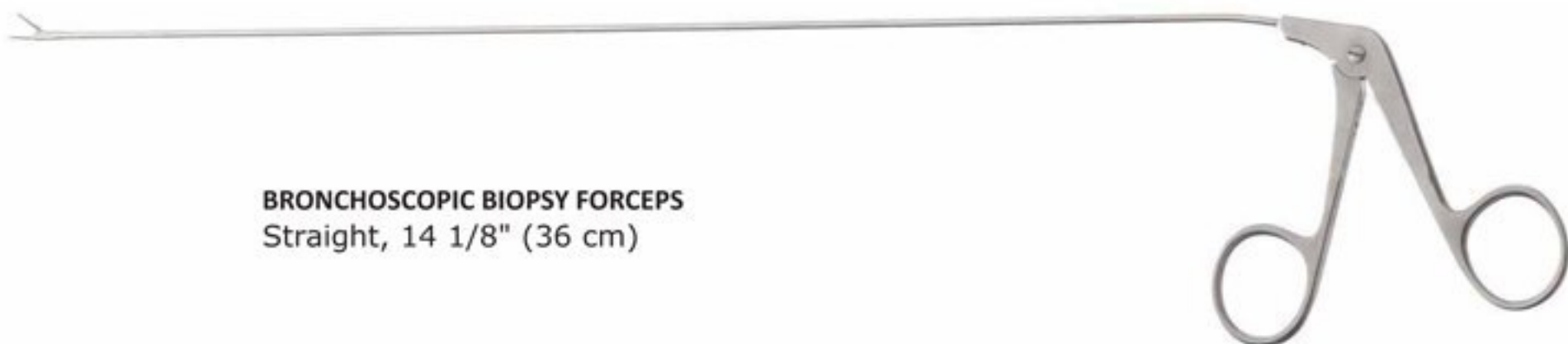

**BRONCHOSCOPIC BIOPSY FORCEPS**  
Straight, 14 1/8" (36 cm)

ETI-201-177



ETI-201-178

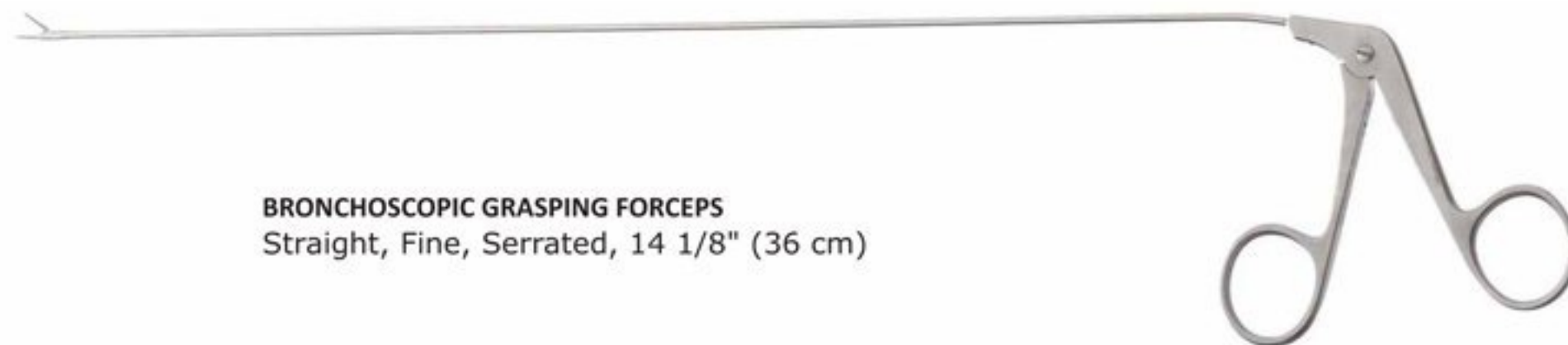

**BRONCHOSCOPIC GRASPING FORCEPS**  
Straight, Fine, Serrated, 14 1/8" (36 cm)

ETI-201-179

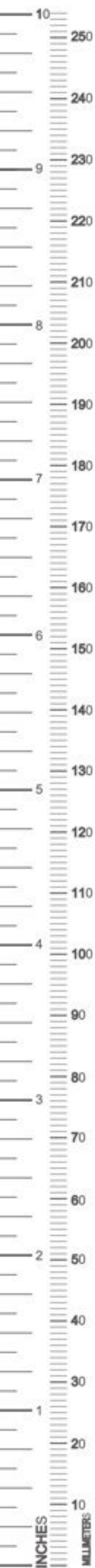



Care with Trust ...

**ENDO TECH**  
Instruments

**Probes, cotton applicators, spatulas**

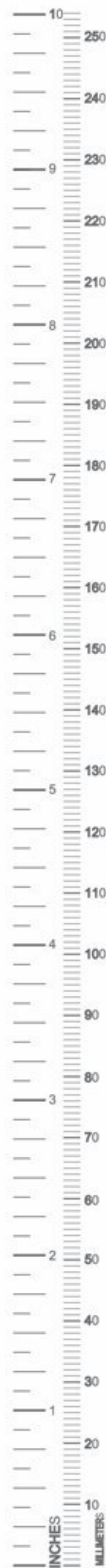
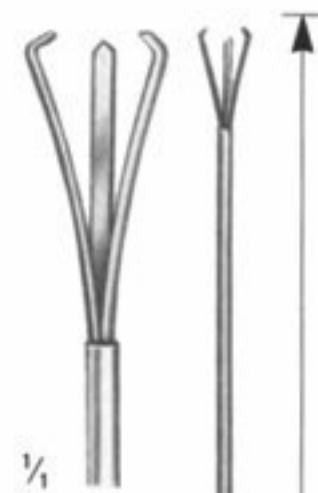
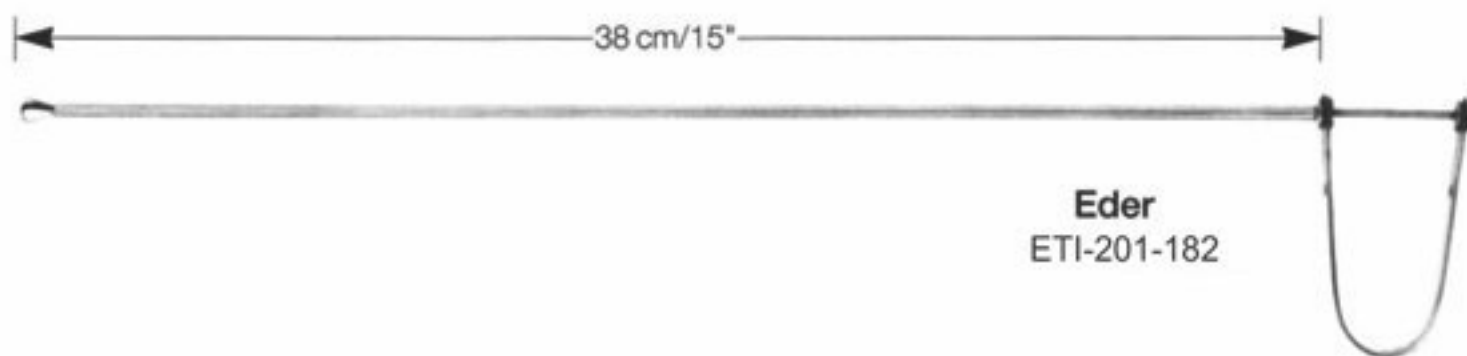
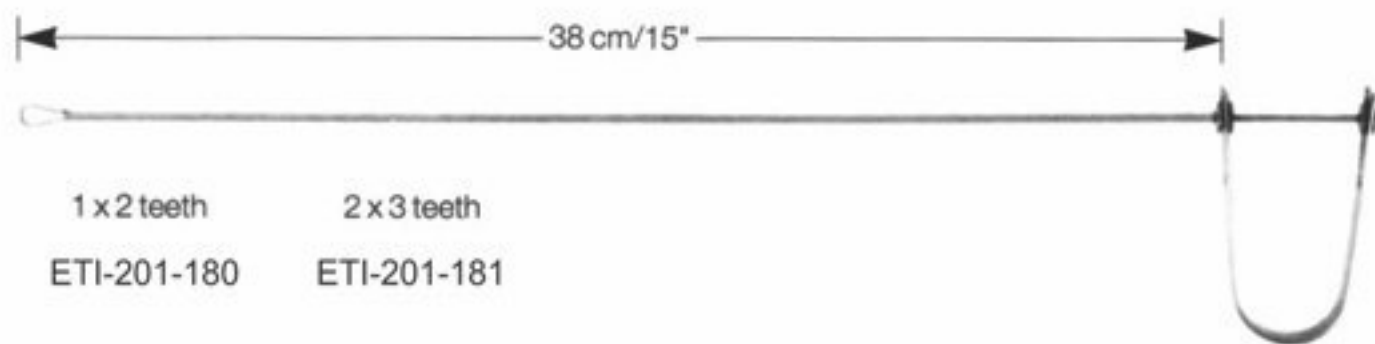



Care with Trust ...

**ENDO TECH**  
Instruments

### Foreign body levers, ear polypus forceps

#### Foreign Body Levers

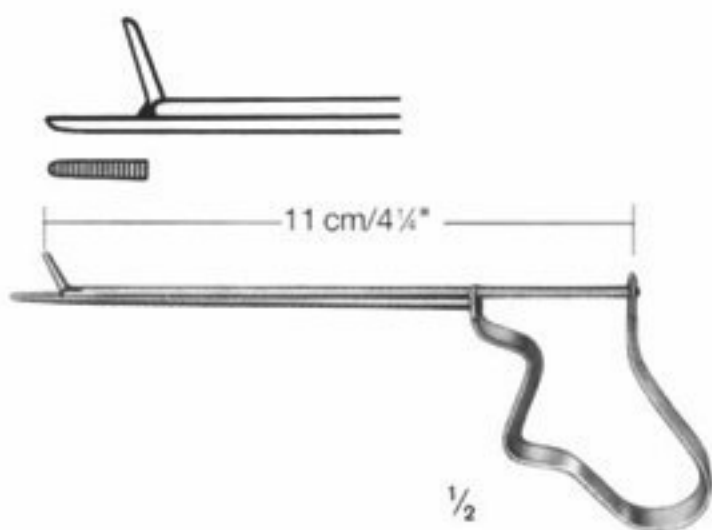

**Buck**  
11 cm/4 1/4"  
ETI-201-184

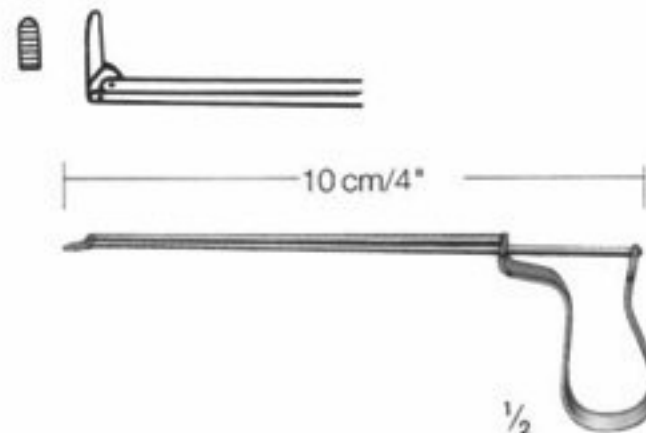

**Quire**  
10 cm/4"  
ETI-201-185

#### Ear Polypus Forceps, Tampon Forceps

delicate pattern

Standard



**Hartmann**  
13,5 cm/5 1/4"  
ETI-201-186



**Hartmann**  
13,5 cm/5 1/4"  
ETI-201-187

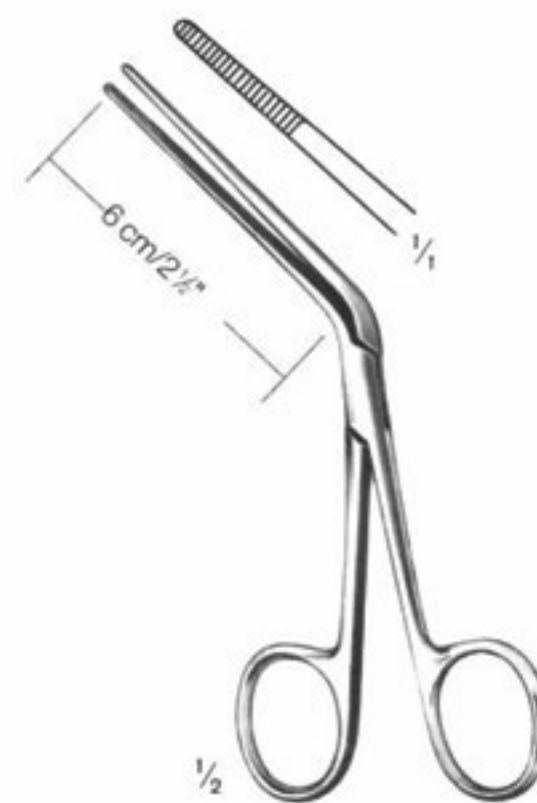

**Tilley (Yankauer)**  
14 cm/5 1/2"  
ETI-201-188

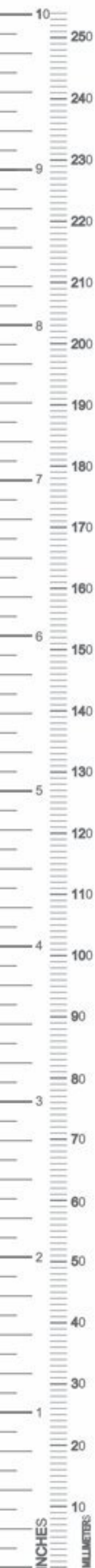



Care with Trust ...

**ENDO TECH**  
Instruments

### Nasal specula



ETI-201-189



ETI-201-190



ETI-201-191



1/2

1/1

**Thudichum (Goldsmith)**



Fig 1

ETI-201-192

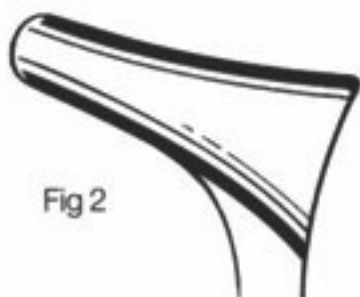

Fig 2

ETI-201-193

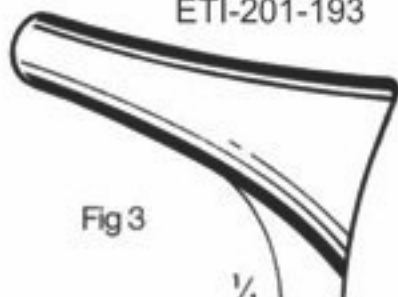

Fig 3

ETI-201-194



1/2

**Modell Wien (Vienna pattern)**  
14 cm/5 1/2"

lightweight

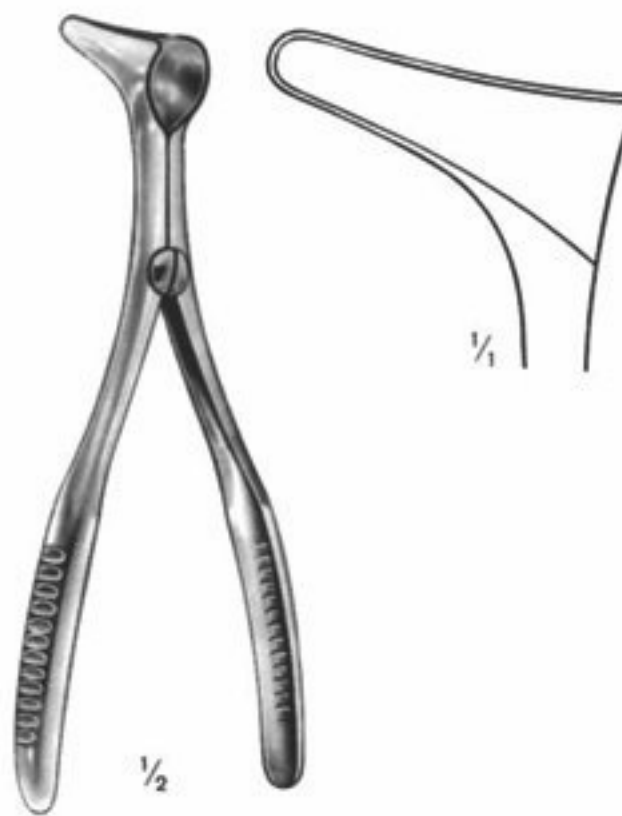

1/1

1/2

**Hartmann/Wiener**  
15 cm/6"  
ETI-201-195

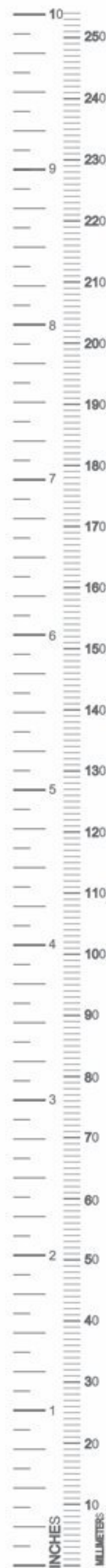



Care with Trust ...

**ENDO TECH**  
Instruments

**Nasal specula**



**Beckmann**  
15 cm/6"



ETI-201-196 Fig. 1



ETI-201-197 Fig. 2



ETI-201-198 Fig. 3



**Hartmann**  
16 cm/6 1/4"



for children



Fig. 0

ETI-201 -199



Fig. 1

ETI-202 -100

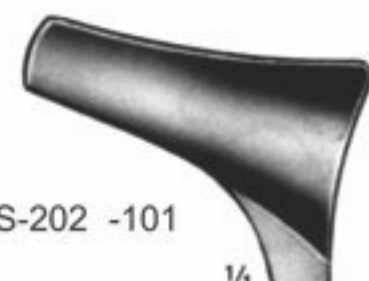

Fig. 2

ETS-202 -101

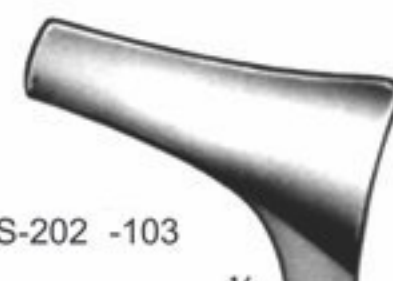

Fig. 3

ETS-202 -103



**Hartmann-Halle**  
15 cm/6"  
ETI-202 -109



Fig. 1

ETI-202 -103  
ETI-202 -104



Fig. 2

ETI-202 -105  
ETI-202 -106



Fig. 3

ETI-202 -107  
ETI-202 -108



**Hartmann-Halle**  
15 cm/6"  
ETI-202 -110



**Sonnenschein**  
15 cm/6"



Fig. 1

ETI-202 -111



Fig. 2

ETI-202 -112



Care with Trust ...

# ENDO TECH Instruments

## Nasal specula



1/2

**Tieck-Halle**  
13,5 cm/5 1/4 \*



Fig. 1 ETI-202 -113

1/1



Fig. 2 ETI-202 -114

1/1



35 mm

Fig. 1

1/1

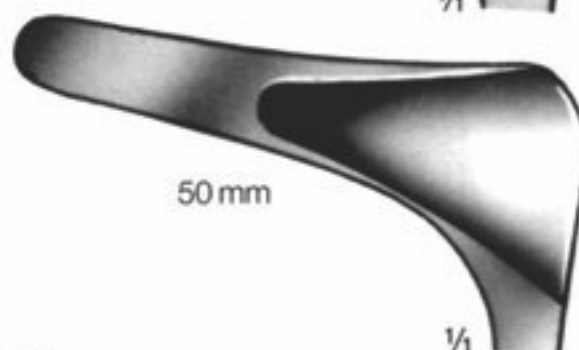

50 mm

Fig. 2

1/1

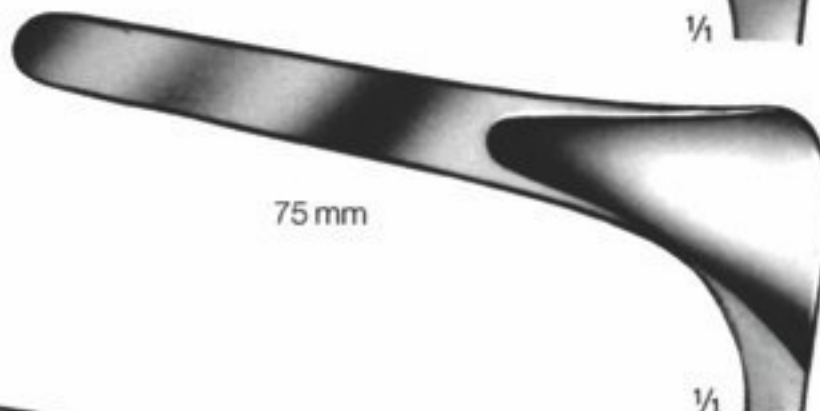

75 mm

Fig. 3

1/1

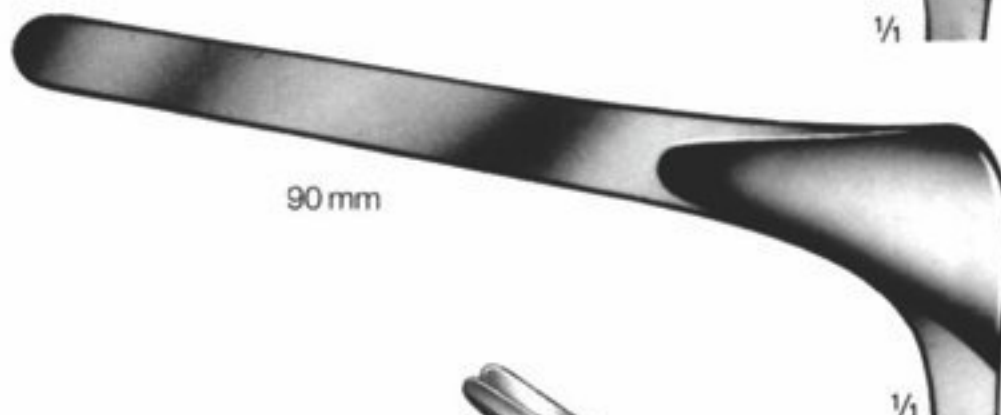

90 mm

Fig. 4

1/1



1/2

**Killian**

13 cm/5 \*

Fig. 1 ETI-202 -115

Fig. 2 ETI-202 -116

Fig. 3 ETI-202 -117

Fig. 4 ETI-202 -118



1/2

**Killian**

13 cm/5 \*

Fig. 1 ETI-202 -119

Fig. 2 ETI-202 -120

Fig. 3 ETI-202 -121

Fig. 4 ETI-202 -122

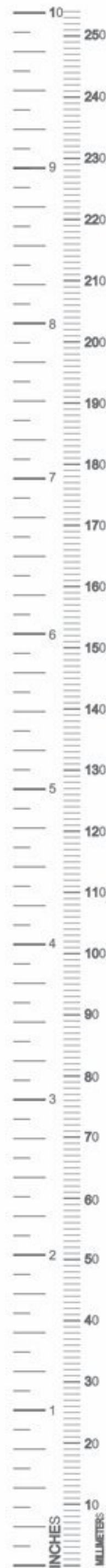



## Nasal specula



1/2

### Cottle

15 cm/6"

Fig. 1 ETI-202 -123

Fig. 2 ETI-202 -124

Fig. 3 ETI-202 -125

Fig. 4 ETI-202 -126

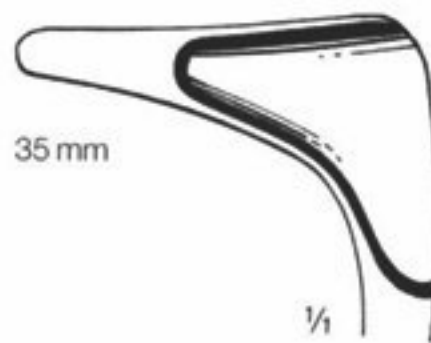

35 mm

1/1

Fig. 1

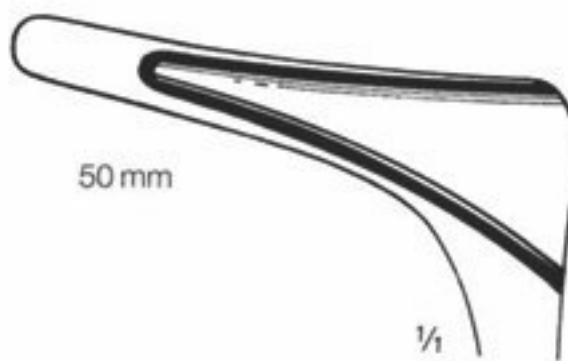

50 mm

1/1

Fig. 2

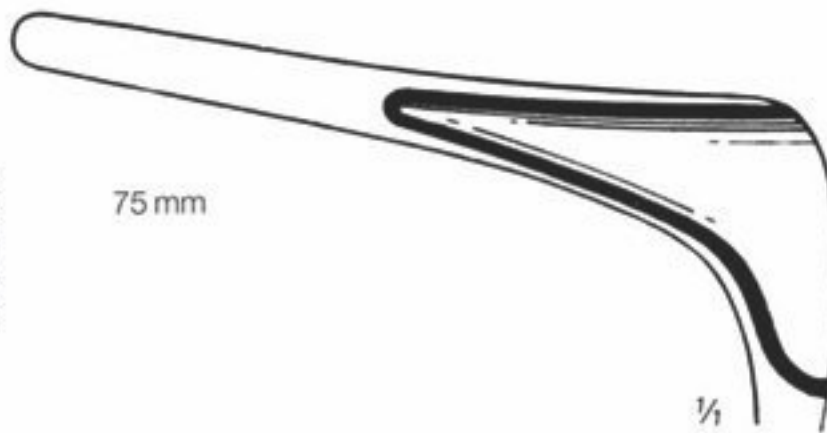

75 mm

1/1

Fig. 3



90 mm

1/1

Fig. 4



1/2

### Cottle

15 cm/6"

Fig. 1 ETI-202 -127

Fig. 2 ETI-202 -128

Fig. 3 ETI-202 -129

Fig. 4 ETI-202 -130



1/2

### Cottle

15 cm/6"

Fig. 1 ETI-202 -131

Fig. 2 ETI-202 -132

Fig. 3 ETI-202 -133

Fig. 4 ETI-202 -134

Nasal Septum Speculum

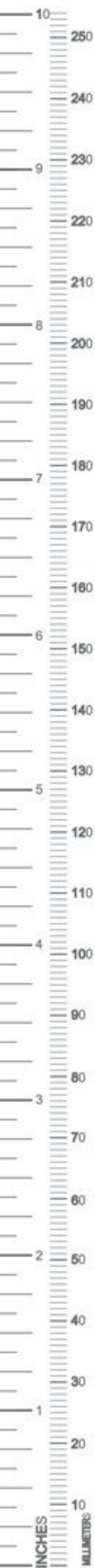



Care with Trust ...

**ENDO TECH**  
Instruments

**Nasal cutting forceps**

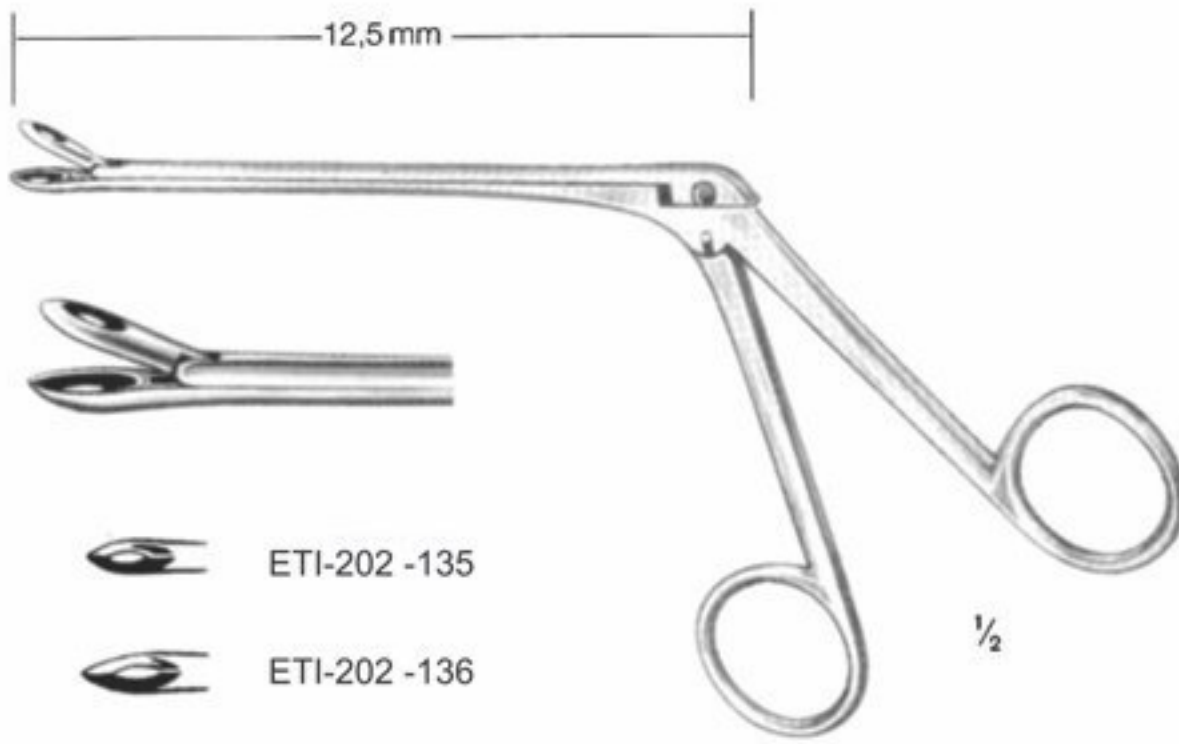

- ETI-202 -135
- ETI-202 -136
- ETI-202 -137
- ETI-202 -138
- ETI-202 -139

$\frac{1}{4}$  **Weil-Blakesley**



- ETI-202 -140
- ETI-202 -141
- ETI-202 -142
- ETI-202 -143
- ETI-202 -144

$\frac{1}{4}$  **Weil-Blakesley**



2,5x10mm ETI-202 -145

4x10mm ETI-202 -146

$\frac{1}{4}$  **Takahashi**



2,5x10mm ETI-202 -147

4x10mm ETI-202 -148

$\frac{1}{4}$  **Takahashi**



ETI-202 -149

ETI-202 -150

$\frac{1}{4}$  **Struycken**



5mm ETI-202-151

7mm ETI-202-152

9mm ETI-202-153

11mm ETI-202-154

$\frac{1}{4}$  **Hartmann**



5mm ETI-202-155

7mm ETI-202-156

9mm ETI-202-157

$\frac{1}{4}$  **Schmeden**

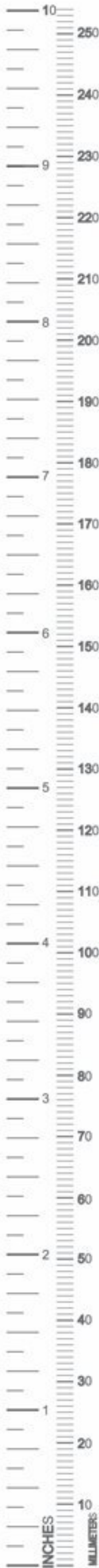



Care with Trust ...

**ENDO TECH**  
Instruments

### Nasal cutting forceps

Antrum Punch, retrograde cutting

10 cm, 4"

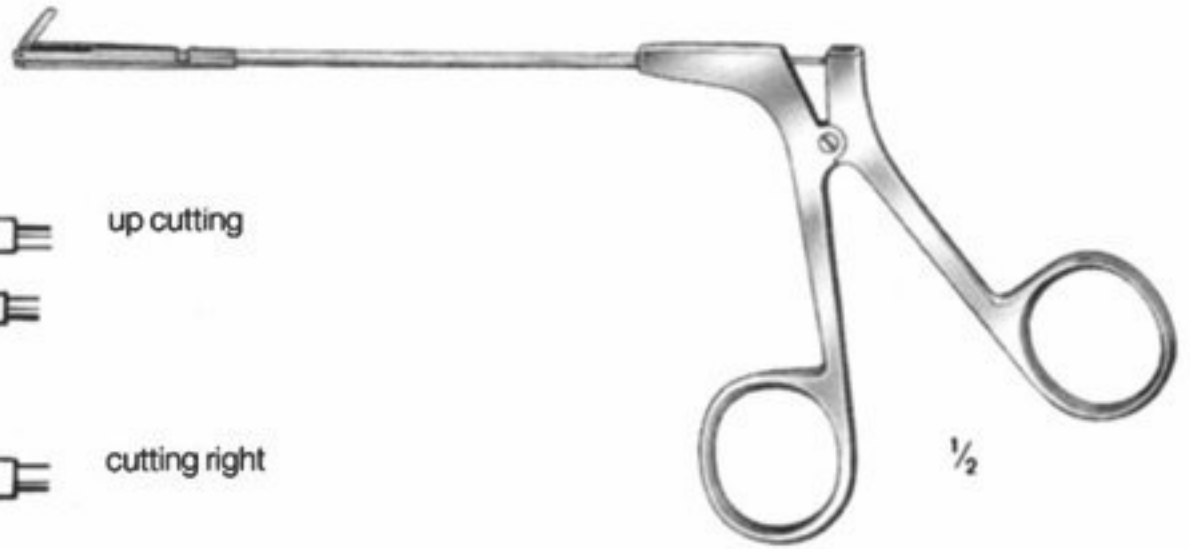

**Stammberger**

ETI-202 -158



up cutting

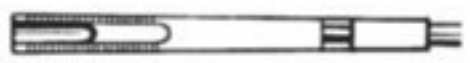

ETI-202 -159



cutting right



ETI-202 -160



cutting left

1/4

Septum Cutting Forceps



through-cutting

1/2

**Jansen-Middleton**  
19 cm/7 1/2"  
ETI-202 -161



spoon-shaped jaws

1/2

**Jansen-Middleton**  
19 cm/7 1/2"  
ETI-202 -162

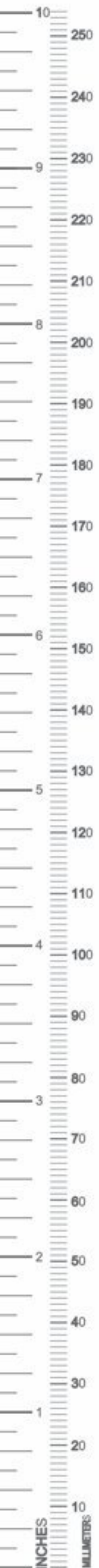



Care with Trust ...

**ENDO TECH**  
Instruments

### Mastoid punches

Fig.0 C 3x3mm ETI-202 -163

Fig.1 C 4x4mm ETI-202 -164

Fig.2 C 5x5mm ETI-202 -165

Fig.3 C 6x6mm ETI-202 -166



1/2  
**Kerrison**



1/2  
**Citelli**

C 1mm ETI-202 -167

C 2mm ETI-202 -168

C 3mm ETI-202 -169



1/2  
**Beyer**

C 1mm ETI-202 -170

C 2mm ETI-202 -171

Atticus Punch





Care with Trust ...

**ENDO TECH**  
Instruments

### Nasal cutting forceps

#### Sphenoid Punches

- |     |  |                              |
|-----|--|------------------------------|
| ∩   |  | 3,5 x 3,5 mm<br>ETI-202 -172 |
| U   |  | 3,5 x 3,5 mm<br>ETI-202 -173 |
| ∩   |  | 4,0 x 4,0 mm<br>ETI-202 -174 |
| ¼ U |  | 4,0 x 4,0 mm<br>ETI-202 -175 |

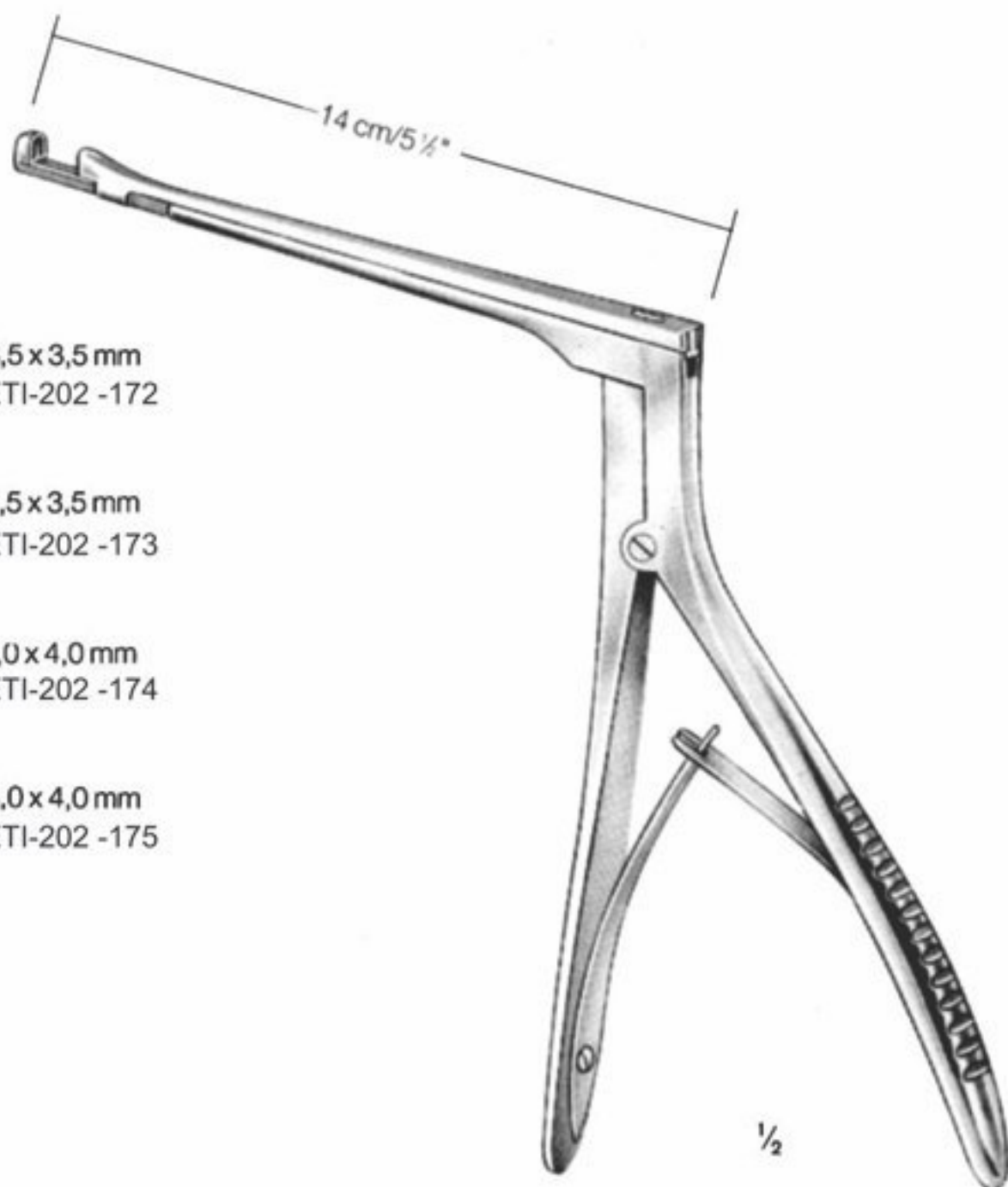

Hajek-Kofler

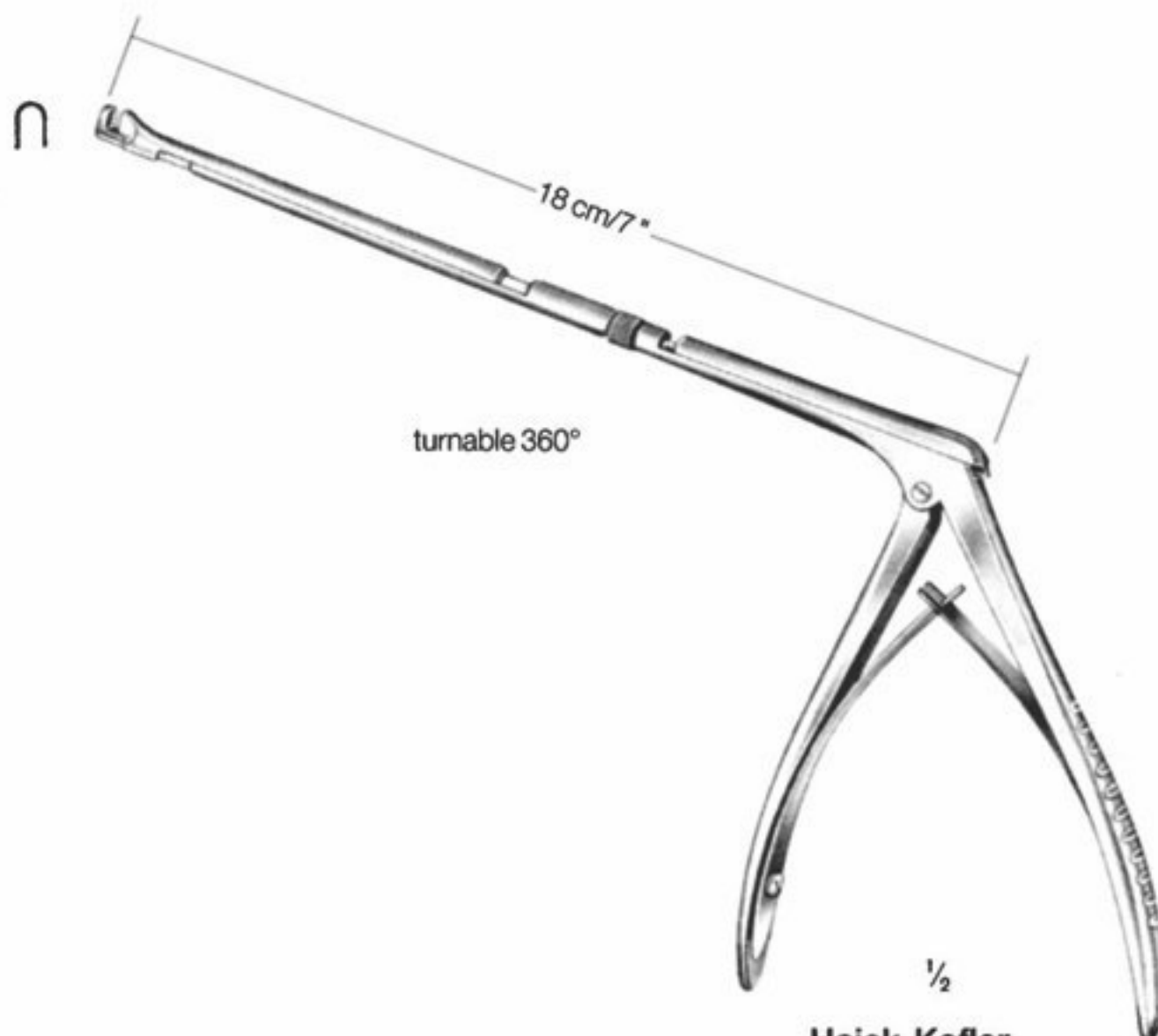

Hajek-Kofler  
ETI-202 -177

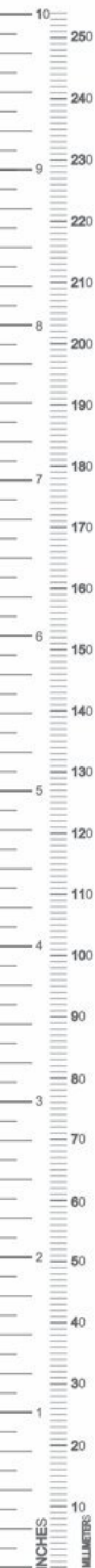



Care with Trust ...

**ENDO TECH**  
Instruments

**Polypus, tampon and septum compression forceps**

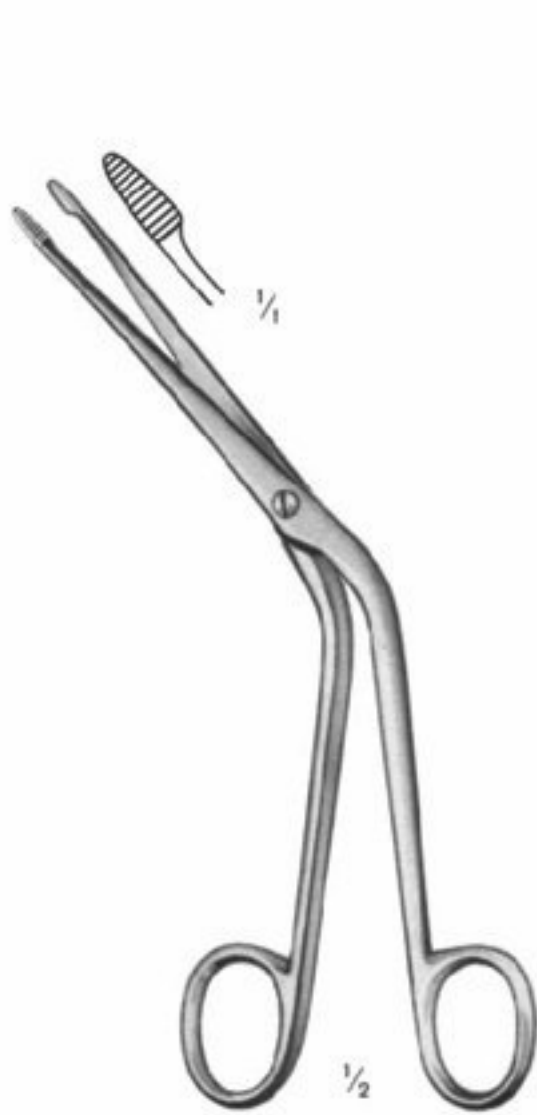

**Hartmann**  
16 cm/6 1/4"  
ETI-202 -177



**Hartmann**  
20 cm/8"  
ETI-202 -178

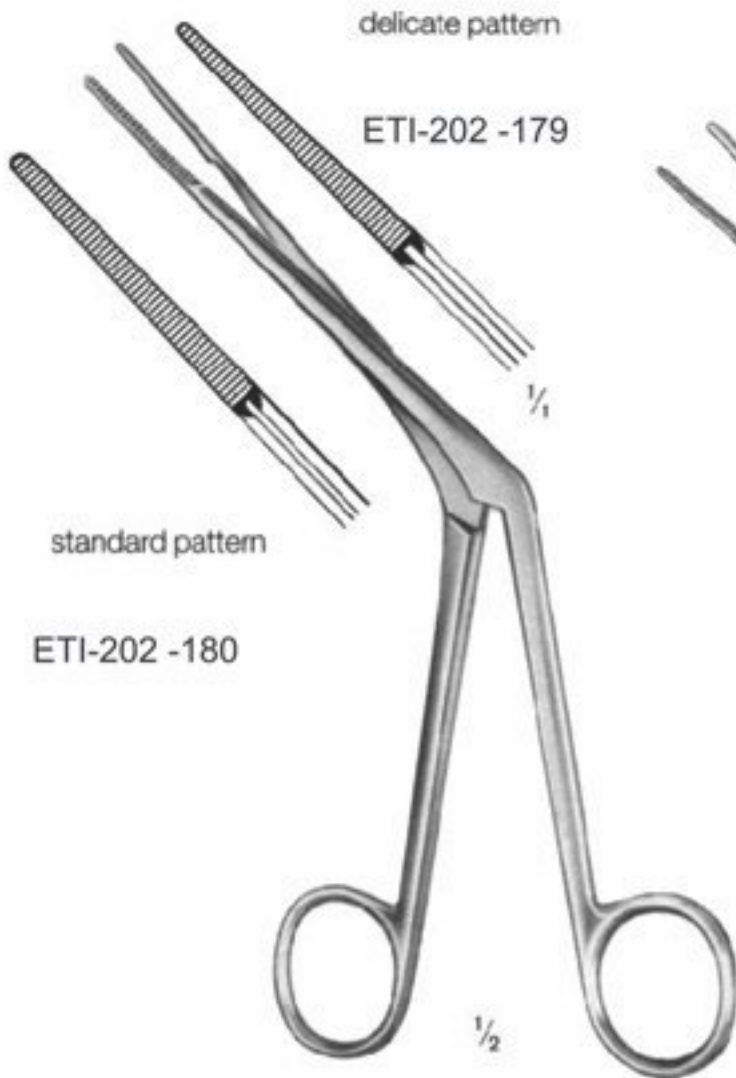

delicate pattern  
ETI-202 -179  
standard pattern  
ETI-202 -180

**Westmacott**  
20 cm/8"

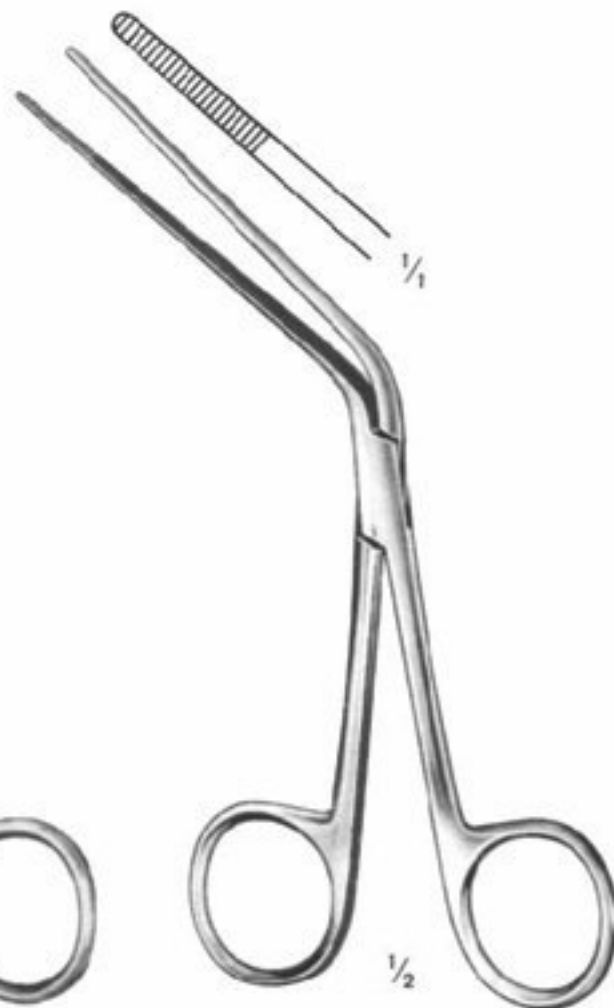

**Tilley**  
17 cm/6 3/4"  
ETI-202 -181

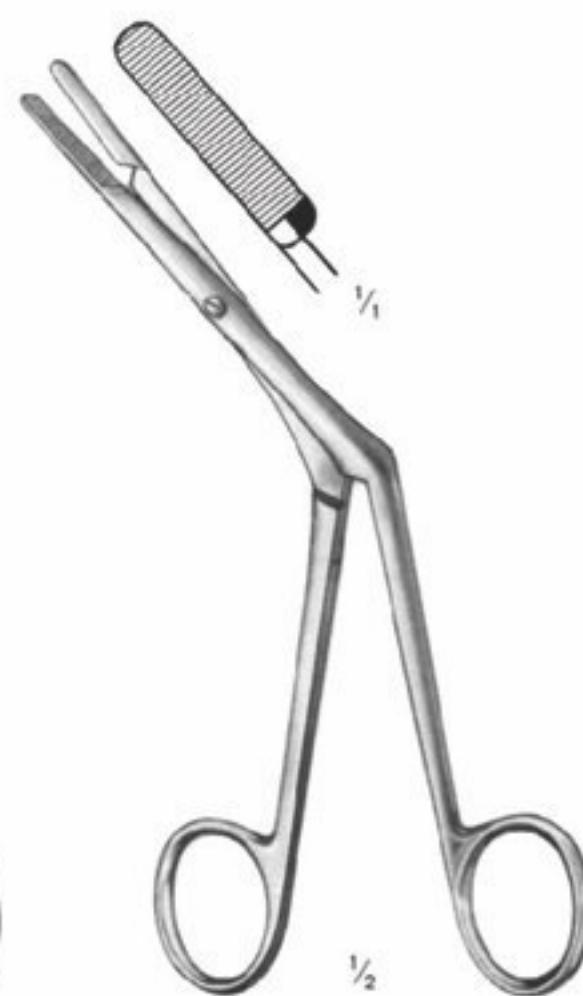

**Killian**  
17 cm/6 3/4"  
ETI-202 -182

Septum Compression Forceps

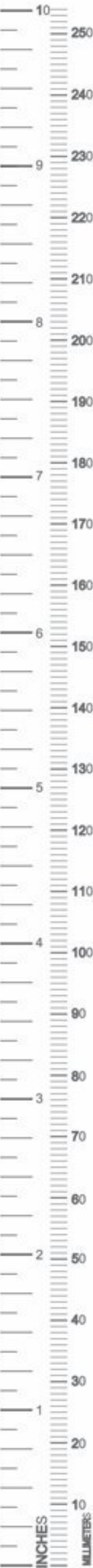



Care with Trust ...

**ENDO TECH**  
Instruments

**Nasal cutting, septum compression and ethmoid forceps**

Septum Compression Forceps

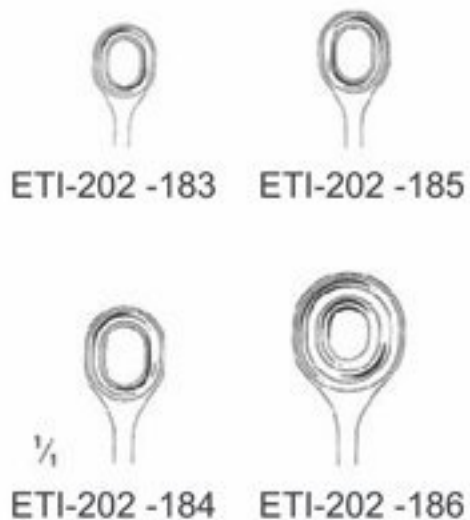
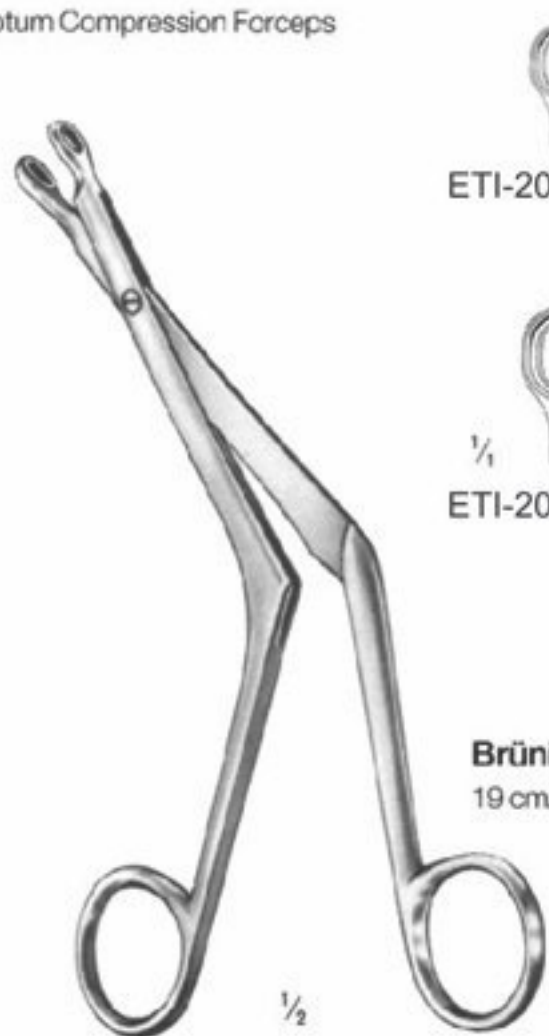

**Brünings**  
19 cm/7½"

½

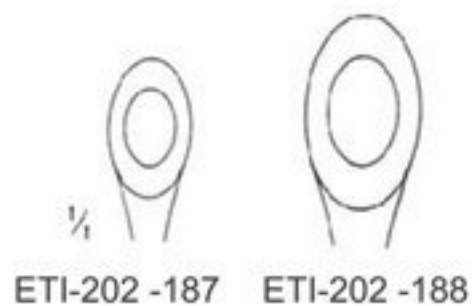
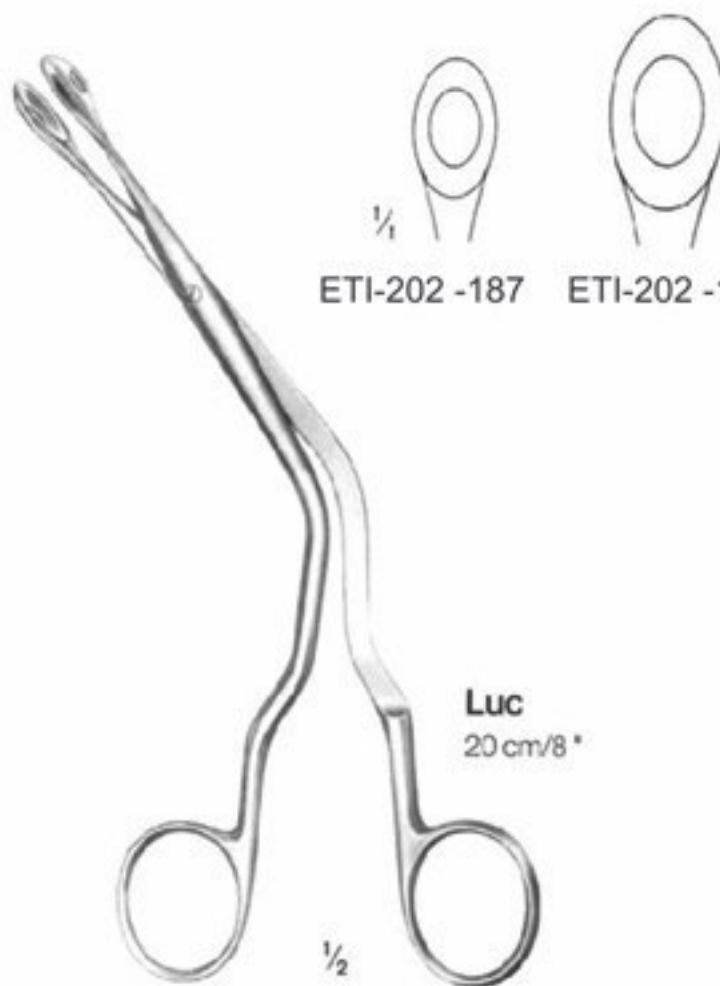

**Luc**  
20 cm/8"

½

Vomer Forceps



**Craig**  
18 cm/7"  
ETI-202 -191

½



**Craig-Domnick**  
18 cm/7"

½

ETI-202 -189 ETI-202 -190

Ethmoid Forceps

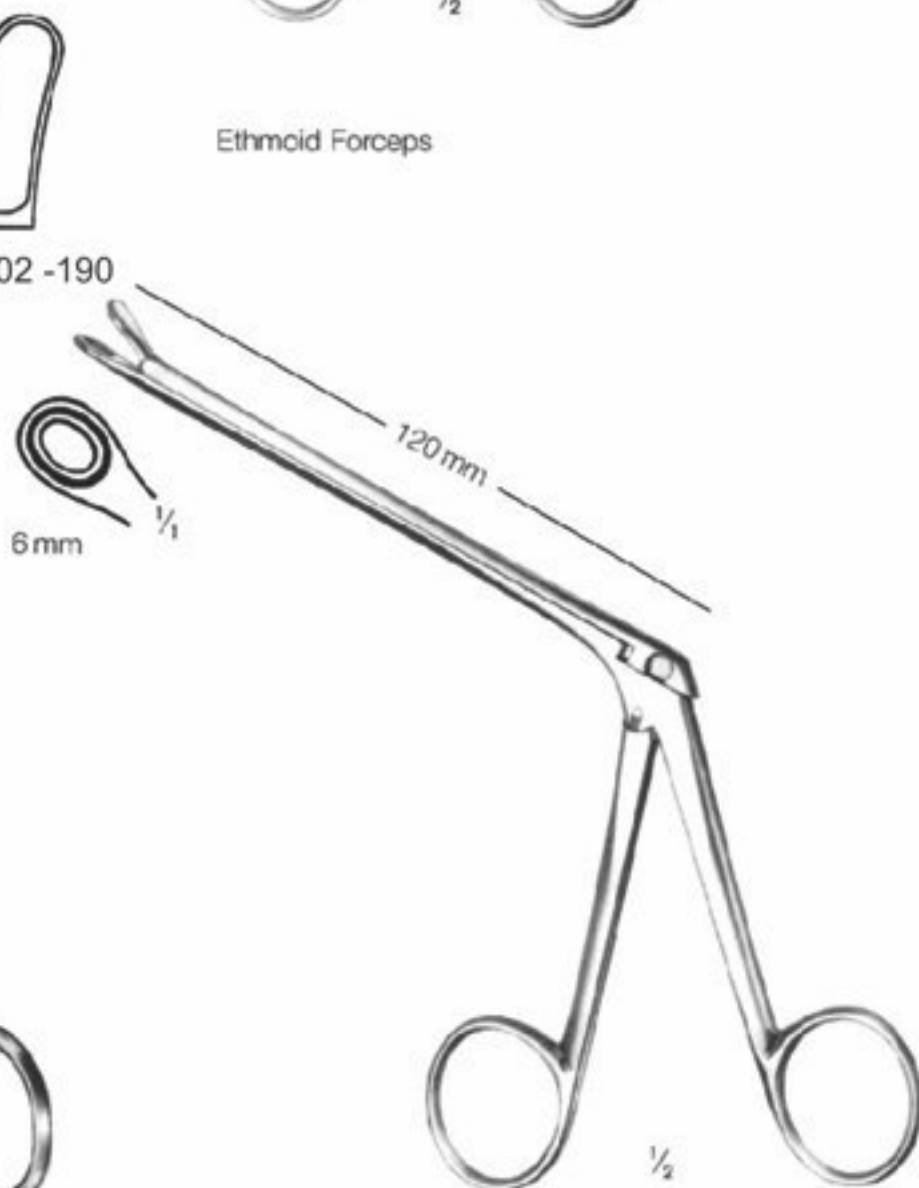

**Watson-Williams**  
19 cm/7½"  
ETI-202 -192

½

6mm

120mm

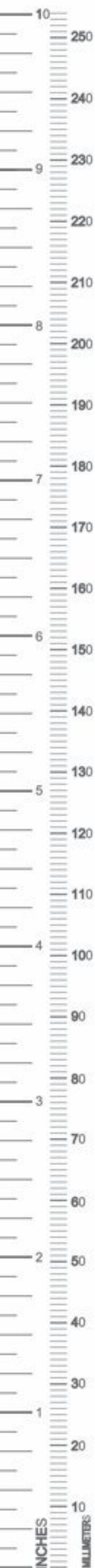



Care with Trust ...

**ENDO TECH**  
Instruments

### Nasal Scissors



**Heymann**  
18 cm/7"  
ETI-202-193



**Knight**  
18 cm/7"  
ETI-202-194

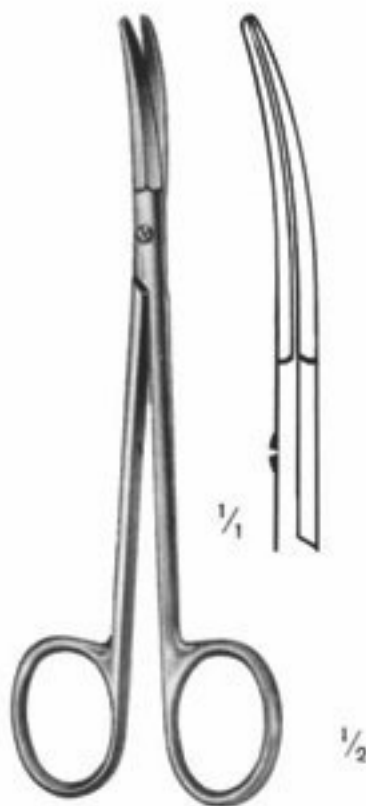

**Fomon "Saber Back"**  
13,5 cm/5 1/4"  
ETI-202-195



**Fomon "Upper Lateral"**  
13,5 cm/5 1/4"  
ETI-202-196

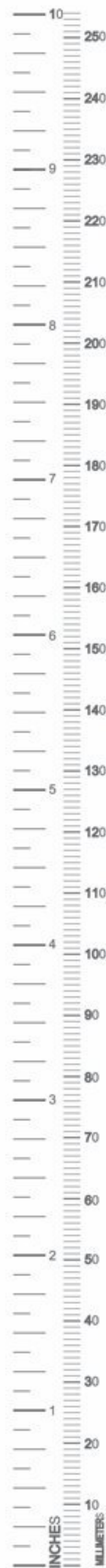



Care with Trust ...

**ENDO TECH**  
Instruments

### Nasal scissors

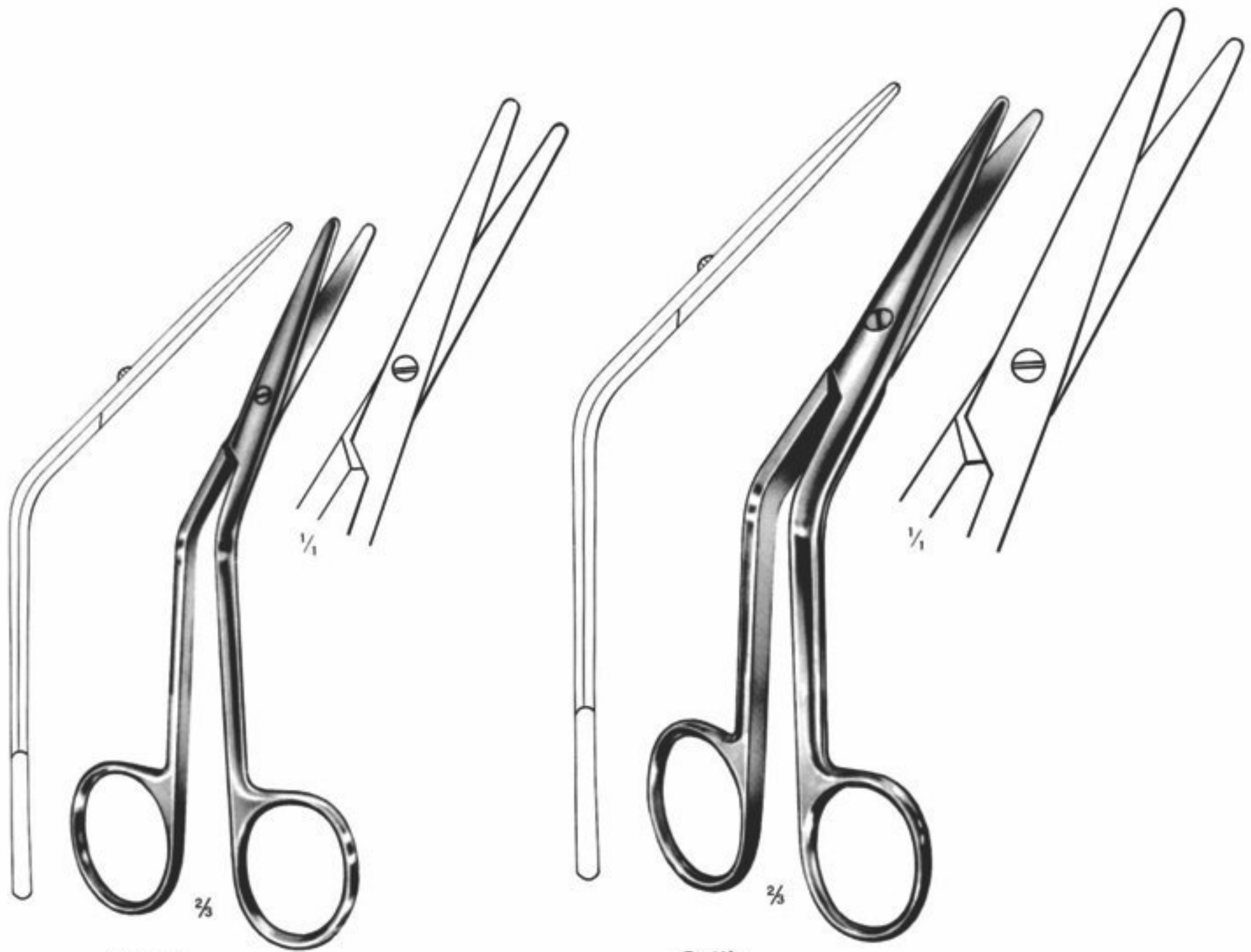

**Fomon**  
14,5 cm/5 3/8"  
ETI-202-197

**Cottle**  
17 cm/6 3/8"  
ETI-202-198

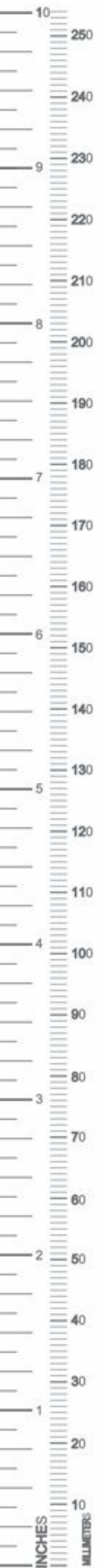



Care with Trust ...

# ENDO TECH

## Instruments

### Self-retaining retractors

4 x 4 teeth sharp

4 x 4 teeth blunt

3 x 3 teeth sharp

3 x 3 teeth blunt



**Jansen**  
10 cm/4"  
ETI-202-199



**Jansen**  
10 cm/4"  
ETI-203-100



**Jansen**  
10,5 cm/4 1/4"  
ETI-203-101



**Jansen**  
10,5 cm/4 1/4"  
ETI-203-102

sharp

blunt



**Plester**  
13 cm/5"  
ETI-203-103

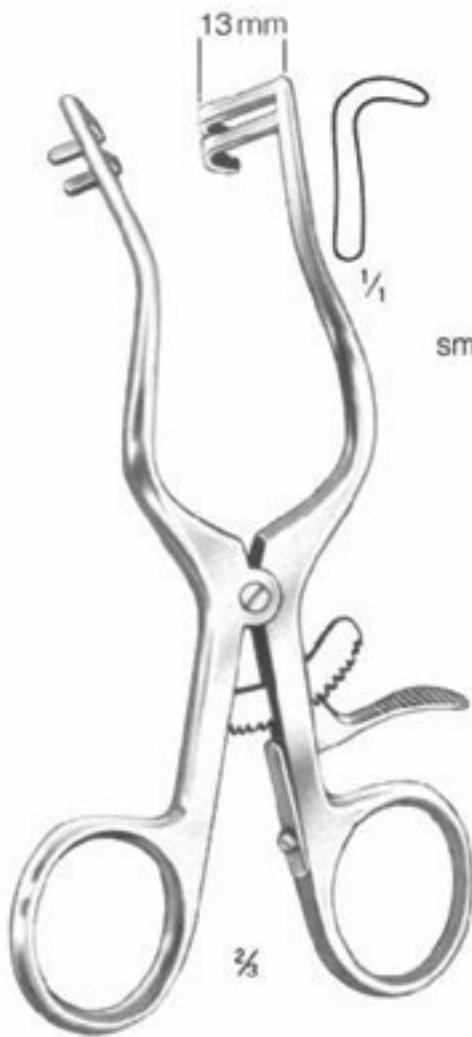

**Plester**  
13 cm/5"  
ETI-203-104

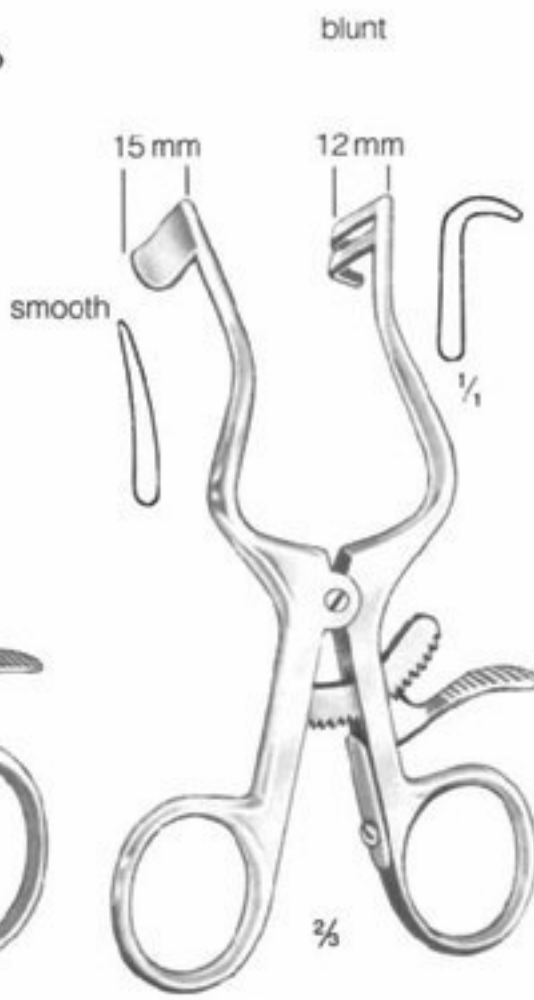

**Plester**  
11 cm/4 1/4"  
ETI-203-105

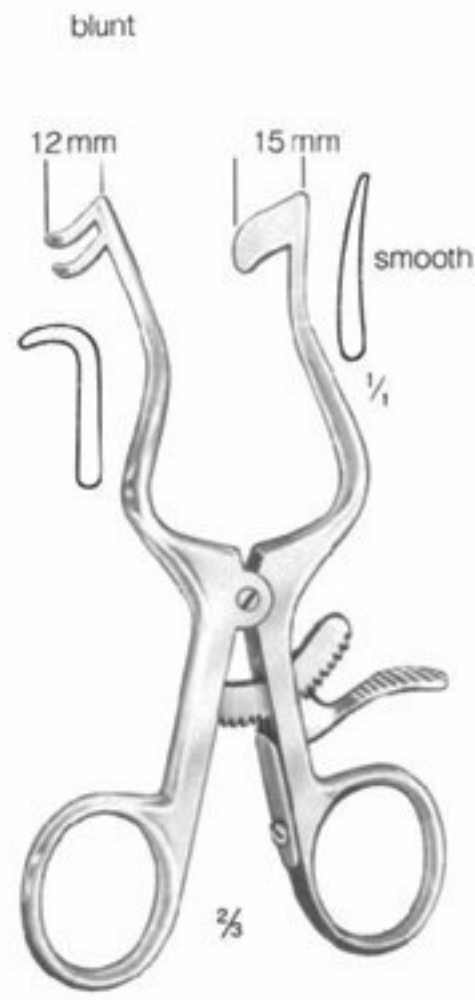

**Plester**  
11 cm/4 1/4"  
ETI-203-106

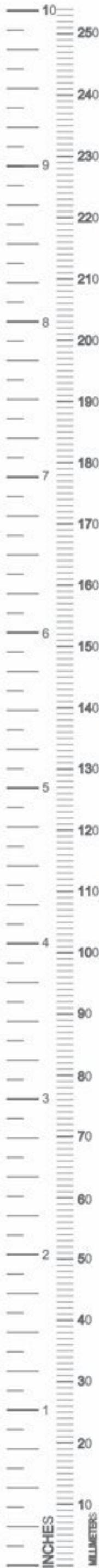



Care with Trust ...

**ENDO TECH**  
Instruments

### Self - retaining retractors

sharp



ETI-203-107  
ETI-203-108

blunt



ETI-203-109  
ETI-203-110

blunt

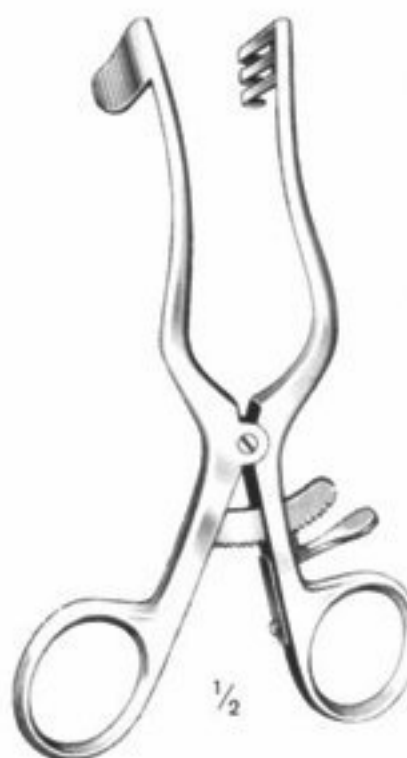

**Perkins**  
13 cm/5"  
ETI-203-111

blunt



**Perkins**  
13 cm/5"  
ETI-203-112

**Wullstein**  
11,5 cm/4 1/2"  
13 cm/5"

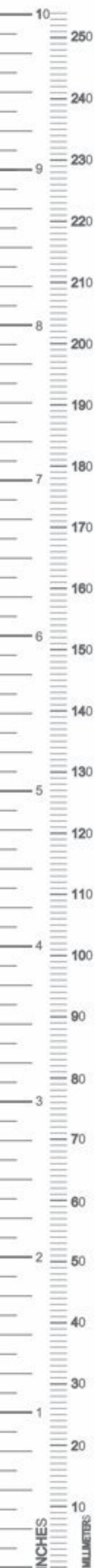



Care with Trust ...

**ENDO TECH**  
Instruments

**Fine wound - and trachea retractors**

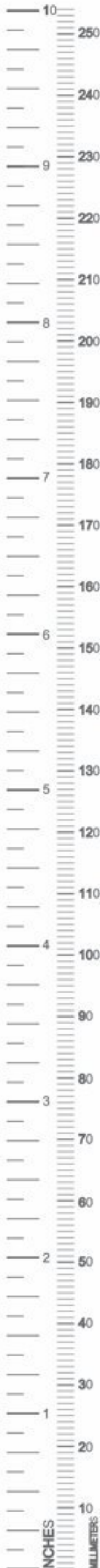
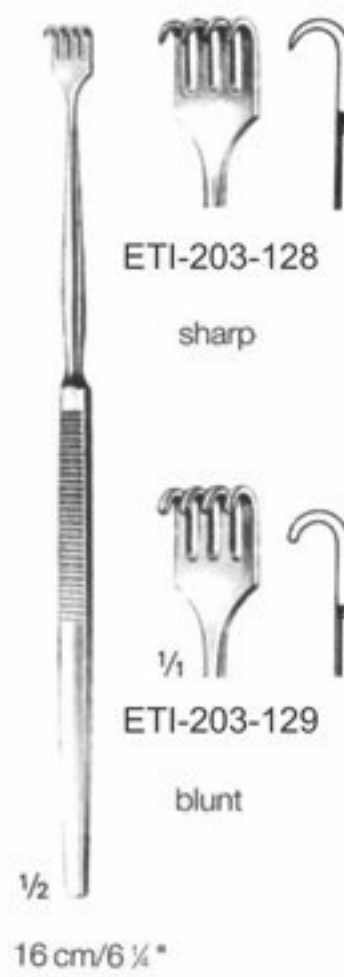
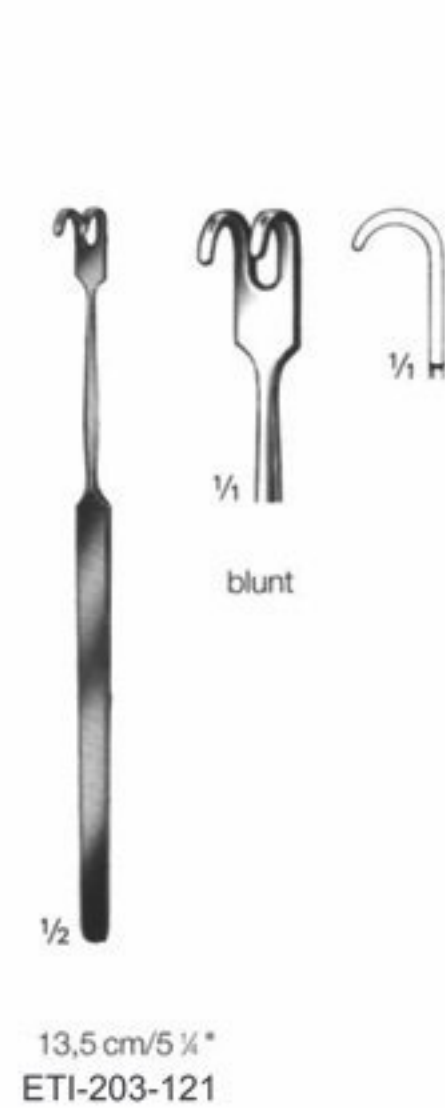
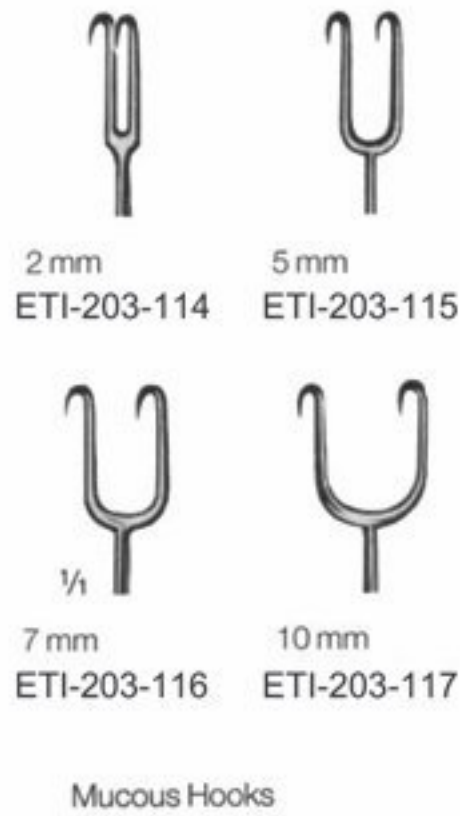



Care with Trust ...

**ENDO TECH**  
Instruments

### Hooks for posterior nares



**Cottle**  
14 cm/5 1/2"  
ETI-203-132



**Cottle**  
14 cm/5 1/2"  
ETI-203-133



**Cottle**  
14 cm/5 1/2"  
ETI-203-134



**Fomon**  
16 cm/6 1/4"  
ETI-203-135



**Neivert**  
20 cm/8"  
ETI-203-136



**Cottle-Neivert**  
20 cm/8"  
ETI-203-137



**Fomon**  
17 cm/6 3/4"  
ETI-203-138



**Lange**  
22 cm/8 3/4"  
ETI-203-139



1/1



**Cottle**  
15 cm/6"  
ETI-203-140



**Aufricht (Walter)**  
13,5 cm/5 1/4"  
ETI-203-141



**Aufricht**  
16 cm/6 1/4"  
L = 45 mm: ETI-203-142  
L = 60 mm: ETI-203-143

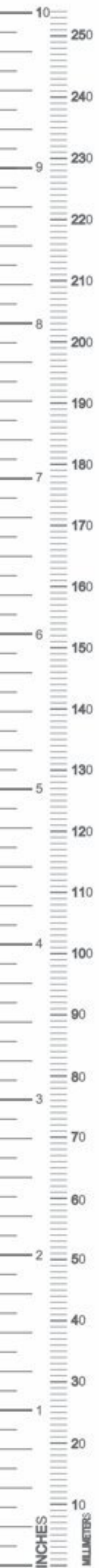



Care with Trust ...

**ENDO TECH**  
Instruments

**Fine hemostatic forceps**



**Adson**  
19 cm/7 1/2"

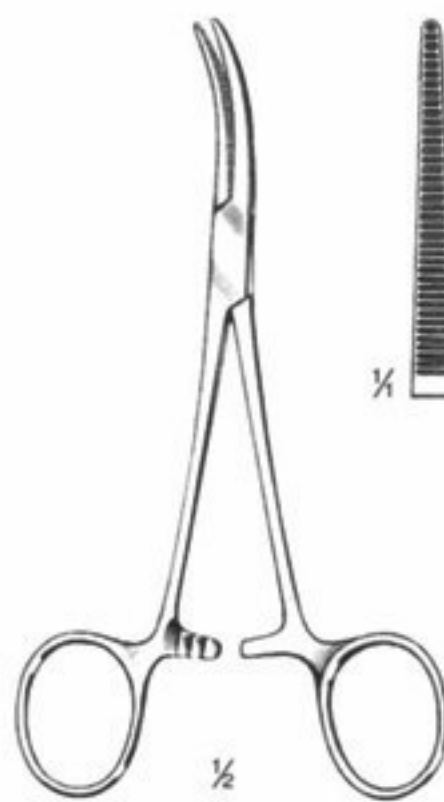
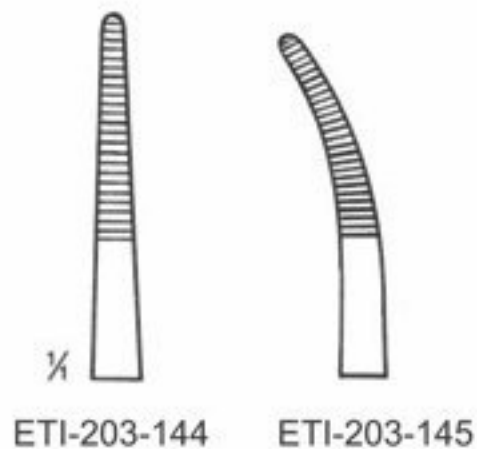

**Dandy**  
14 cm/5 1/2"  
ETI-203-146

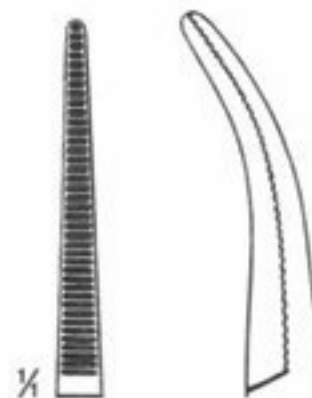

**Providence-Hospital**  
14 cm/5 1/2"



**Leriche**  
15 cm/6"

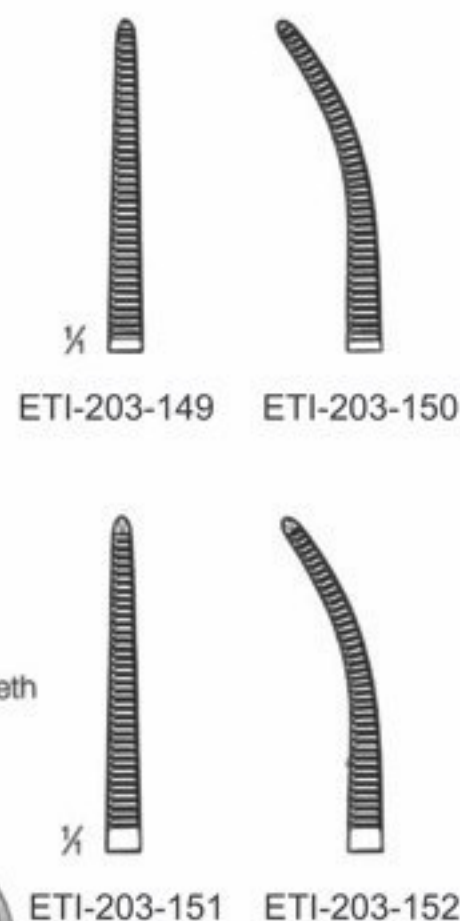

1 x 2 teeth

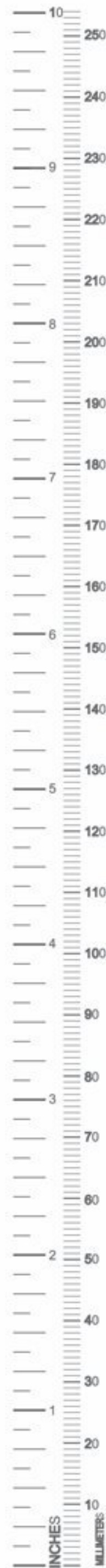



Care with Trust ...

**ENDO TECH**  
Instruments

**Fine hemostatic forceps**

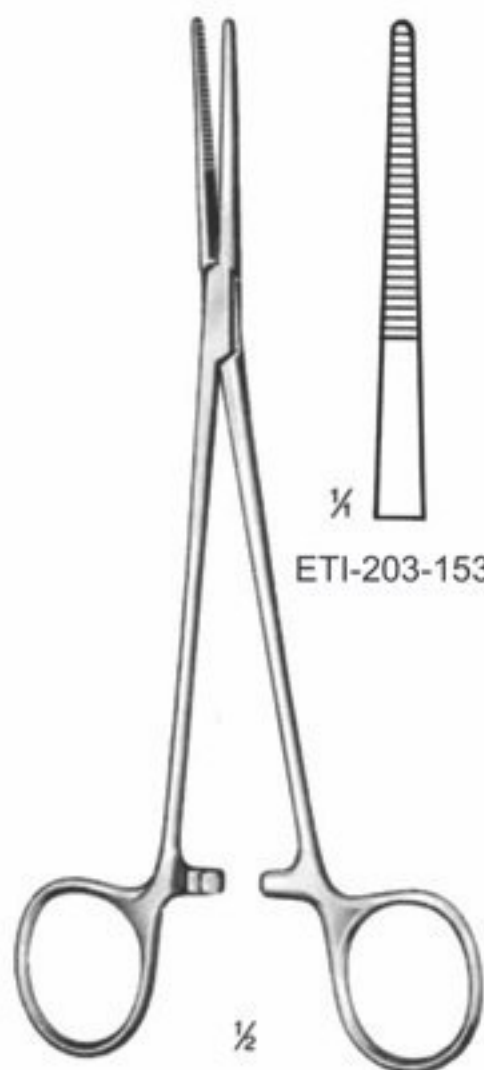

**Birkett**  
19 cm/7 1/2"

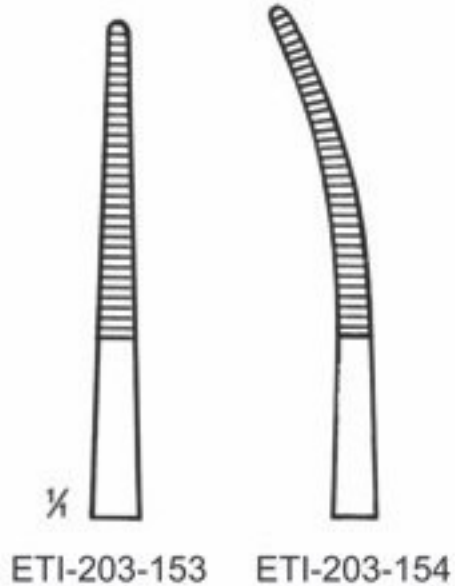

ETI-203-153 ETI-203-154

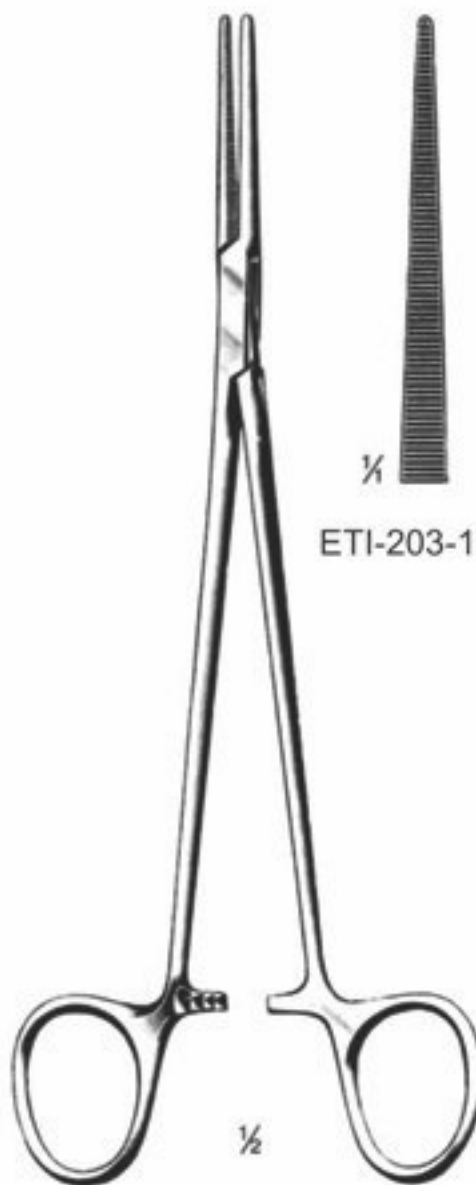

**Heiss**  
20 cm/8"

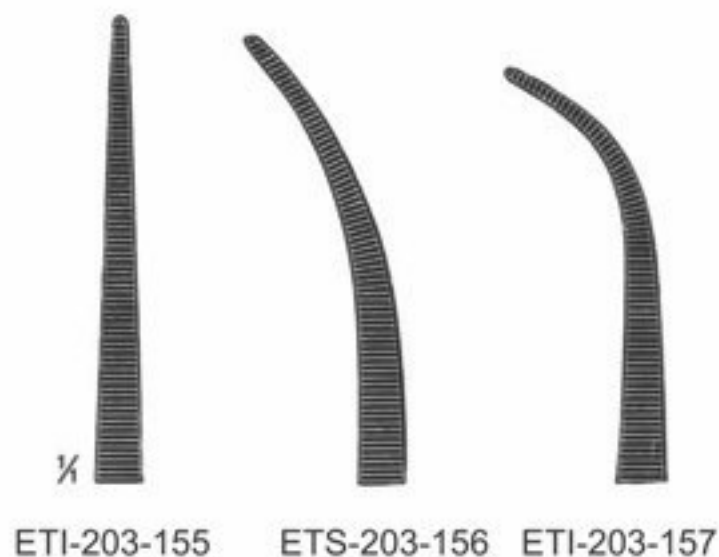

ETI-203-155 ETS-203-156 ETI-203-157

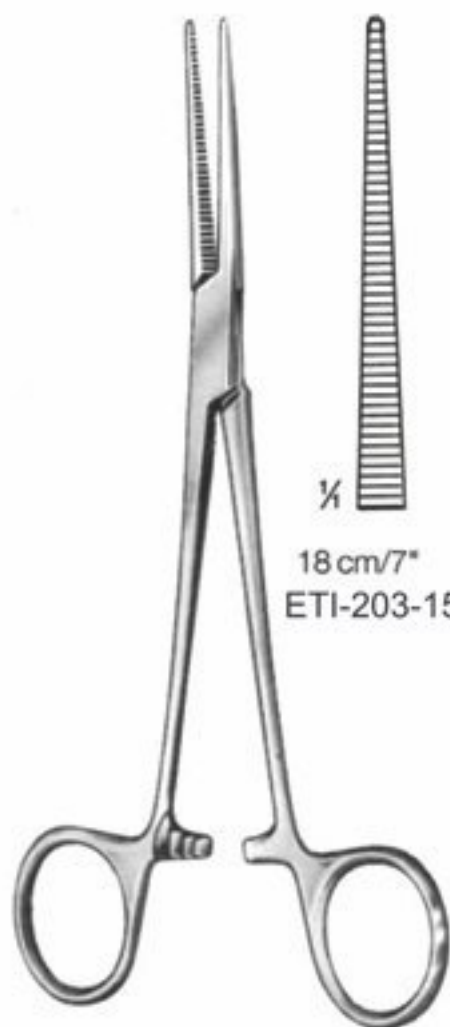

**Olivecrona (Crafoord)**

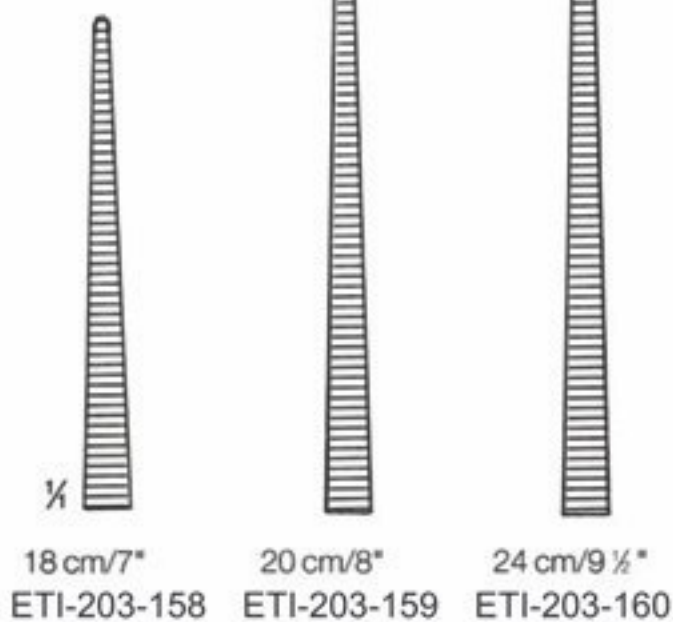

18 cm/7" ETI-203-158  
20 cm/8" ETI-203-159  
24 cm/9 1/2" ETI-203-160

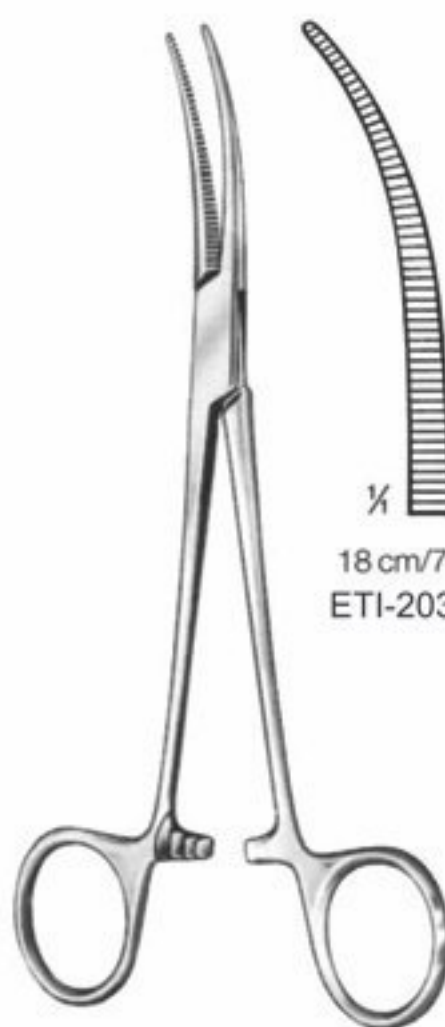

**Crafoord (Coller)**

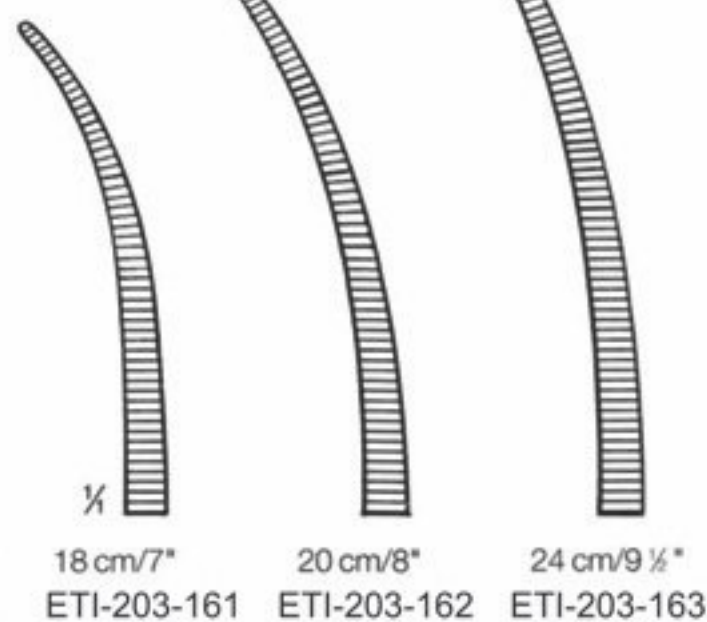

18 cm/7" ETI-203-161  
20 cm/8" ETI-203-162  
24 cm/9 1/2" ETI-203-163

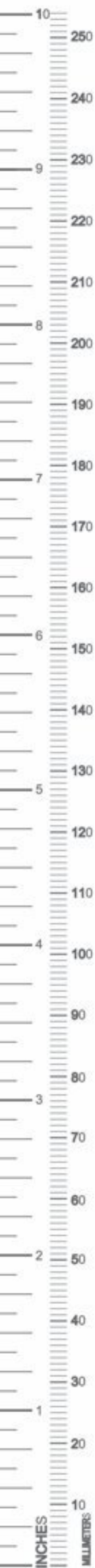



Care with Trust ...

**ENDO TECH**  
I n s t r u m e n t s



Care with Trust ...

**ENDO TECH**  
I n s t r u m e n t s

P.O Box # 963 Ghtto Rora, Aiman Abad Raod,  
Sialkot-51310-Pakistan.

Cell: +92 333 8720804 / 92 333 3232456 / 92 300 0400601

Local: +92 52 3525629

Fax: +92 52 3525629

E-mail: [info@endotech.com.pk](mailto:info@endotech.com.pk) Web : [www.endotech.com.pk](http://www.endotech.com.pk)



**ISO 13485**  
Certified





Care with Trust ...

**ENDO TECH**  
I n s t r u m e n t s

## **ADDRESS**

A Fine Instruments Manufactures Company

Al muslim street islam nagar

Sialkot - 51340 Pakistan

**Cell:** +92 3338720804

**Phone:** +92-52-4352088

**Email:** [info@endotech.com.pk](mailto:info@endotech.com.pk)

**Web:** [www.endotech.com.pk](http://www.endotech.com.pk)